



Pipetting Guide

Workflow Planning  
Pipette Selection  
Tip Selection  
Techniques  
Accuracy

## Guide to Good Pipetting Get Better Results

**METTLER TOLEDO**



<b>01</b>	<b>Foreword</b>	<b>4</b>
<b>02</b>	<b>Project Planning and Optimizing Workflow</b>	<b>6</b>
	Analyzing the Workflow	8
	Optimizing the Workflow	9
<b>03</b>	<b>Pipette Selection</b>	<b>14</b>
	Air Displacement Pipettes	16
	Pipetting Cycle and Technique	17
	Positive Displacement Pipettes	20
	Sample Properties	21
	Pipettes	24
	Specialty Pipettes	30
<b>04</b>	<b>Pipette Tip Selection</b>	<b>34</b>
	Pipette Tips	36
	Specialty Tips	38
	Tip Quality	44

---

<b>05</b>	<b>Pipetting Techniques</b>	<b>48</b>
	Operating Range	50
	Tip Immersion	51
	Aspiration	52
	Dispensing	54
	Pre-rinsing	55
	Environment	56
	Adjusting Volumes	57
	Routine Cleaning	58
	Ergonomic Pipetting	60
<b>06</b>	<b>Pipetting Accuracy</b>	<b>64</b>
	Uncertainty of the Pipette	66
	Safe Pipetting Range	68
<b>07</b>	<b>Preventive Maintenance, Calibration and Verification</b>	<b>72</b>
	Preventive Maintenance and Calibration	74
	Pipette Verification	75
	Pipette Management	77

# Foreword

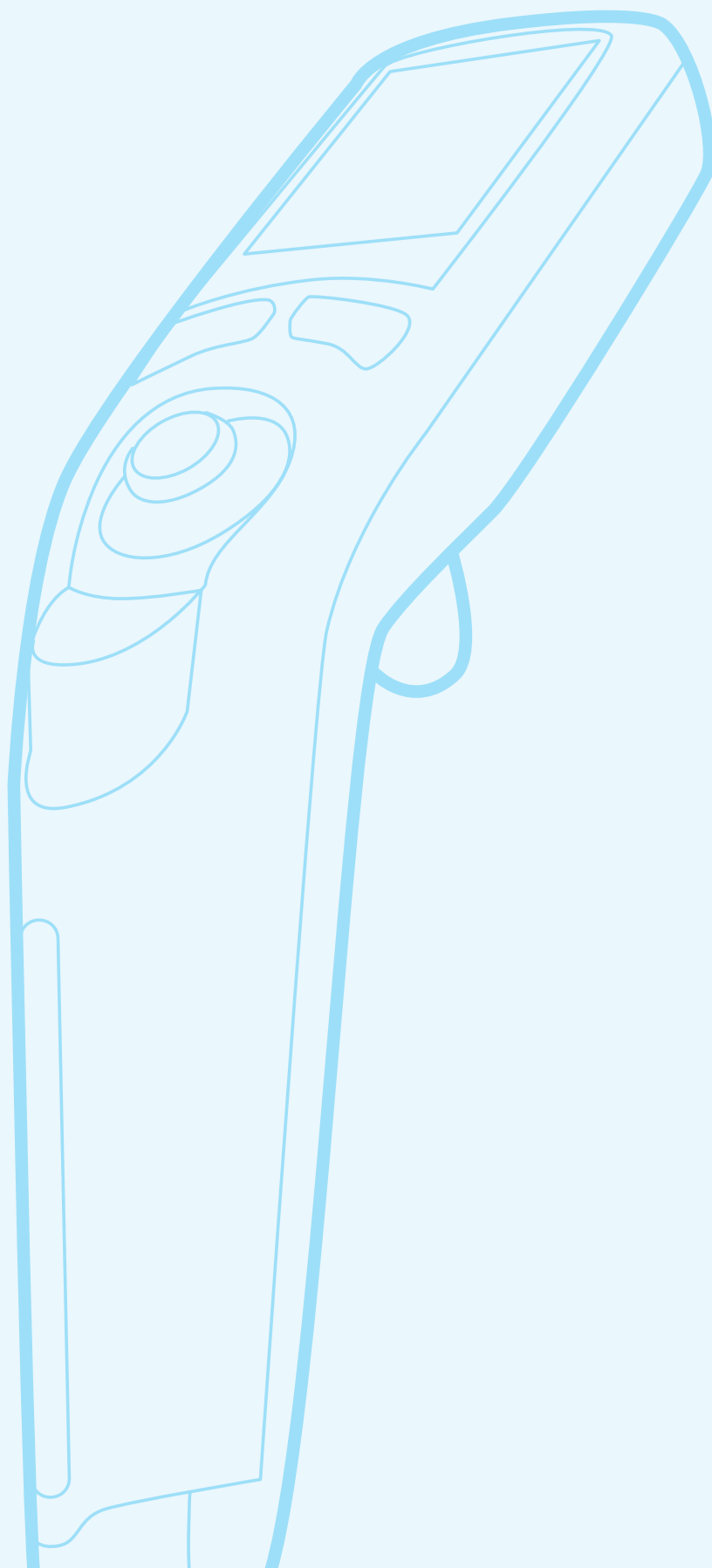

---

## Foreword

Pipetting – measuring and transferring small volumes of liquid in the microliter and milliliter range – is probably the most frequently practiced activity in most life science labs today. Understanding the basics of good pipetting practice is important to the success and reproducibility of any experiment. No matter how precise a pipette is, the skill and knowledge of the user ultimately determines the accuracy and reliability of their results.

Pipetting as a technique has not changed over time. We still follow the same instrumentation principles, yet the complexity of the assays, new protocols or techniques and the number of analyzed samples have increased significantly in recent years. Even though robotics and automation are advancing discoveries in biological sciences, new technology has not been able to substitute for the role of pipettes. Pipettes remain essential in any lab, no matter the size of the project or the area of research.

As the manufacturer of Rainin pipettes, METTLER TOLEDO is keenly interested in helping every researcher become a pipetting expert. For more than a decade, researchers around the world have been attending Rainin Good Pipetting Practice workshops and using this handbook to improve their pipetting techniques, optimize their workflows and get better, more reliable results.

Good Pipetting Practice (GPP) is a systematic approach developed by METTLER TOLEDO to help researchers achieve accurate, reproducible results by making informed choices on equipment selection, proper pipetting and ergonomic techniques, calibration and routine operation. From selecting the right tip for a particular liquid to optimizing your workflows, this pipetting handbook is an indispensable reference tool for new and experienced pipette users alike.

Lastly, although examples in this handbook may refer to Rainin pipettes and data, the principles and techniques apply to any brand of pipette.

# Project Planning and Optimizing Workflow

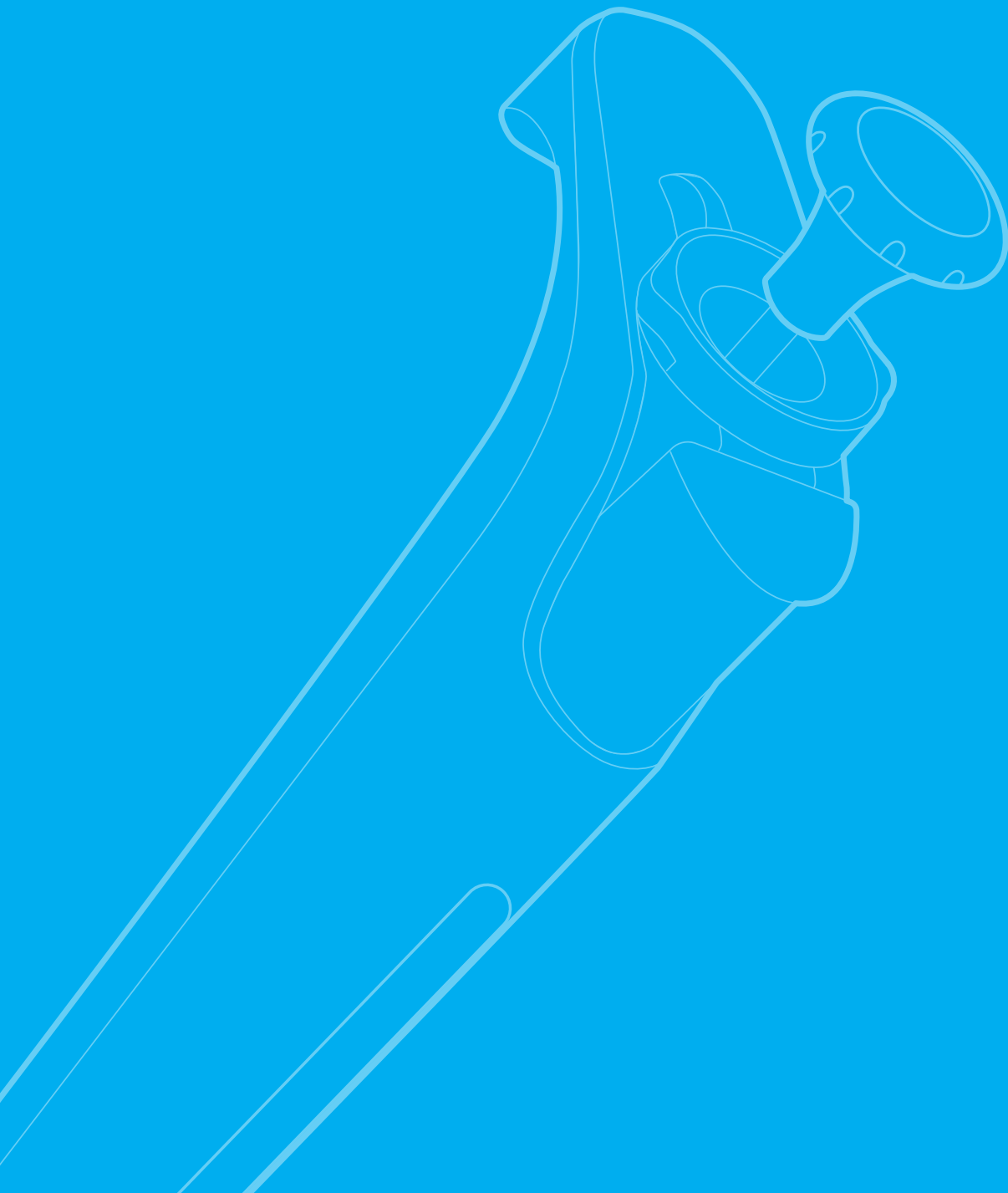

---

## Project Planning and Optimizing Workflow

For maximum efficiency and consistent high-quality data generation, it is important to understand the overall experimental workflow and plan ahead to determine all the steps needed for completion. This will help establish the project scope, determine the correct amount and type of equipment, reagents and consumables to purchase, and identify potential bottlenecks that can cause problems, extend the duration of the project or adversely affect data quality.

Understanding the sample type, sample throughput and end-point analysis method is important for determining the optimal liquid-handling tools (pipettes and tips), pipetting techniques and the liquid-handling formats (tubes, plates, etc.) required for the workflow.

For any pipetting activity, to deliver the accurate volume of liquid, consider the pipette, the associated tip and the operator's technique as one system. Choosing the correct pipette and tip, then using the most effective technique, are integral parts of designing and implementing any life science project or experiment.

## Analyzing the Workflow

Step one in the process is to identify all of the necessary steps in an experimental workflow. From initial sample isolation to final data collection and analysis, this includes all the preparation steps to support the workflow (e.g., the buffer or mastermix preparations).

Step two is to identify how much variability is tolerable to consider the experiment reproducible. Some applications and steps are more sensitive to experimental variability than others. For example, any experiment involving quantitative amplification, such as real-time PCR (qPCR), can be very sensitive to even minor variability while a simple buffer preparation step may not.

A less than optimal choice of pipette and tip – as well as poor pipetting technique – can be a major source of experimental variability. Thus, any experiment dependent on a standard curve generated through the serial dilution of standards can be severely affected by suboptimal pipetting.

### Analyzing the workflow

1. Identify all steps in workflow
2. Identify applications and steps most likely to introduce variability
3. Identify maximum tolerance for experimental variability

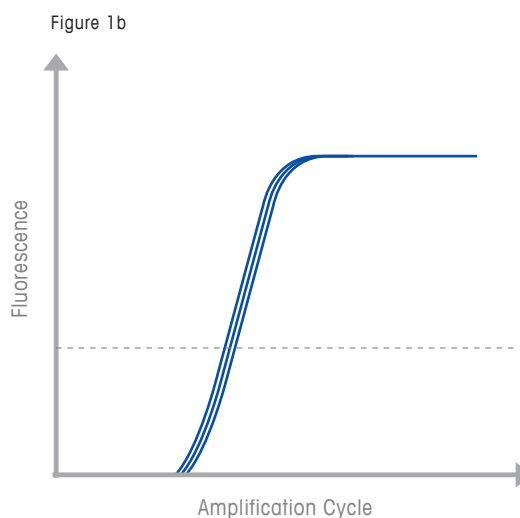
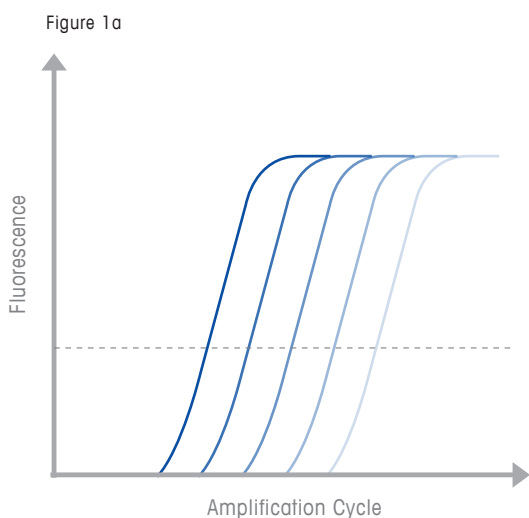

**Figure 1a and 1b. qPCR amplification curves generated for serial dilutions.** Ideally, during the exponential phase, serial dilutions should produce amplification curves that are evenly spaced to designate doubling with each amplification cycle (Figure 1a). Technical replicates within each dilution should overlap (Figure 1b) to indicate optimal amplification efficiency. Suboptimal pipettes, tips and technique can cause unwanted shifts in amplification curves and affect downstream analysis.



# Optimizing the Workflow

## Volume range and sample throughput requirements

A workflow often involves starting with several liquids at relatively large volumes (e.g., preparing buffers, plating cells, etc.), where transferring 5 or 10 mL with less emphasis on accuracy may be common. However, the final analysis technique may use only small volumes, resulting in an increased need for better volume delivery.

With smaller volumes, the need for speed and accuracy must be balanced since large-volume tools have different capabilities. Selecting the appropriate tools to support the desired volume range transfer will maximize accuracy and precision.

If the number of samples to be analyzed is high enough (e.g., 24 or 48 samples), it may make sense to switch from a tube to a plate format for sample preparation and/or analysis, in which case, using multichannel pipettes will speed up the workflow. It is worth noting that while sample preparation can be time consuming, multichannel pipettes don't always offer sufficient finesse in specific steps (e.g., separating layers, biphasic samples). The physical limitations of a multichannel pipette must be weighed against the need to achieve necessary sample processing throughput.

If multiple 96- or 384-well plates are being analyzed, consider using a 96-channel pipetting instrument, which will save time and reduce the chance of errors.

For an explanation on pipetting accuracy and how it affects reproducibility, see Pipetting Accuracy, pages 64-71.

Pipette Type	Rainin Pipette Model	Minimum Nominal Range	Maximum Nominal Range	Systematic Error (10%)	Random Error (10%)	Systematic Error (50%)	Random Error (50%)	Systematic Error (100%)	Random Error (100%)
Air Displacement	L-10XLS+	1 µL	10 µL	2.50 %	1.20 %	1.50 %	0.60 %	1.00 %	0.40 %
	L-200XLS+	20 µL	200 µL	2.50 %	1.00 %	0.80 %	0.25 %	0.80 %	0.15 %
	L-1000XLS+	100 µL	1000 µL	3.00 %	0.60 %	0.80 %	0.20 %	0.80 %	0.15 %
Positive Displacement	MR-25	5 µL	50 µL	8.30 %	2.60 %	2.70 %	0.80 %	1.20 %	0.40 %
	MR-250	25 µL	250 µL	3.00 %	0.60 %	1.70 %	0.30 %	1.00 %	0.20 %
	MR-1000	100 µL	1000 µL	3.00 %	1.60%	1.00 %	0.50 %	0.80 %	0.40 %

**Table 1. Comparison of the volume capacities for Rainin air displacement (page 16) and positive displacement pipettes (page 20).** Selecting the appropriate pipette model to support the desired volume range transfer will maximize accuracy and precision.

### Sample/reagent container format requirements

Using 96-well plates may require moving multiple samples or reagents from tubes to plates or vice versa, and sometimes transfers are required between different plate formats (24- to 96-well). Adjustable spacer multichannel pipettes can cut format change time by as much as 85% as users can move up to eight samples at a time (e.g., moving samples from a non-formatted set of tubes into a formatted 96-well plate only requires moving the tubes onto a microtube rack).

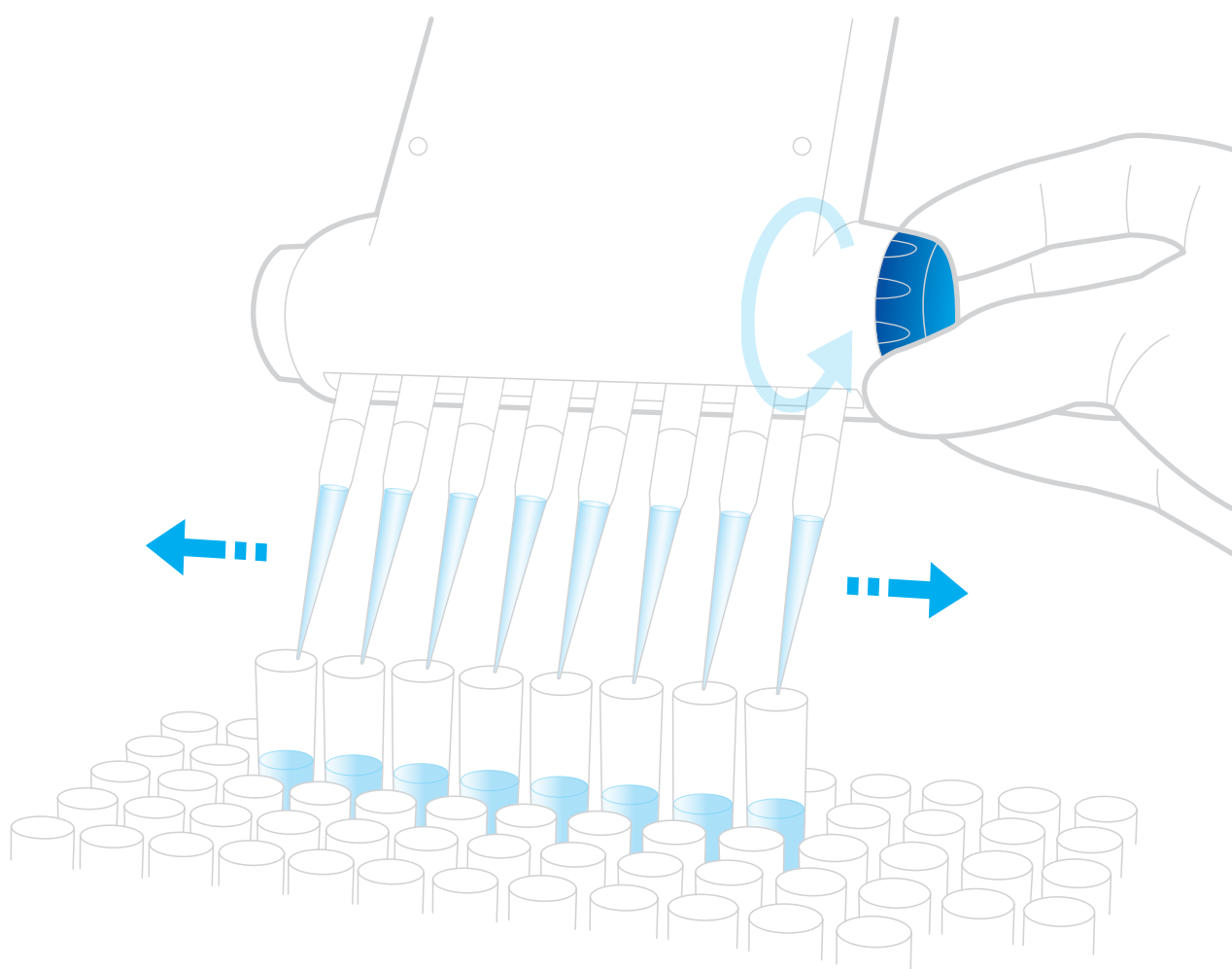

Figure 2a. Turning the spacing adjustment knob on a Rainin XLS Adjustable Spacer pipette to accommodate tube formats or wider spacing formats.

The continuous variable spacing mechanism on an adjustable spacer multichannel pipette allows users to quickly set spacing between the channels at the same time ensuring identical spacing between all channels. Once the format limiter (i.e., maximum spacing distance) is set, users can quickly move samples between different plate and tubing formats using a spacing adjustment knob.

### Adjustable spacer multichannel pipettes

Efficiently transfer multiple  
samples simultaneously

- Between tubes to plates  
(and vice-versa)
- Between different plates  
(24/48/96-wells)

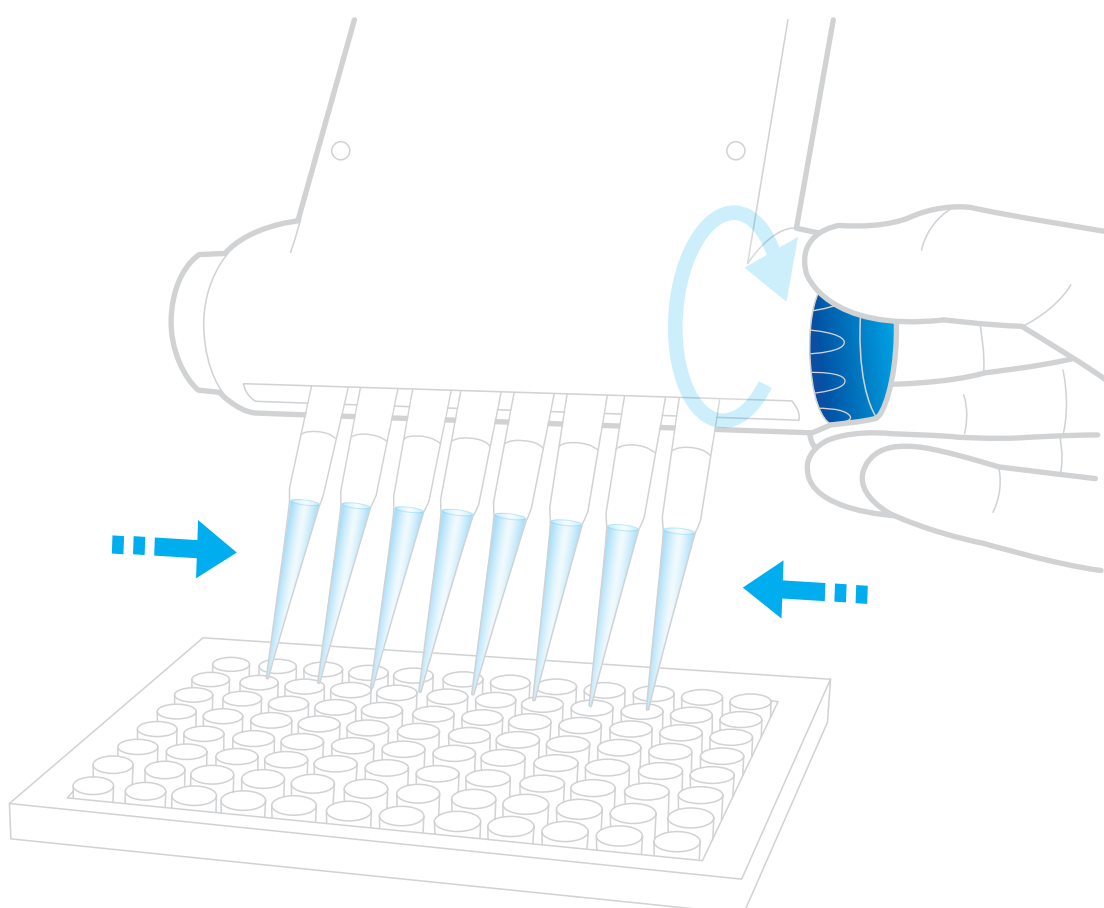

► [www.mt.com/adjustable-spacer](http://www.mt.com/adjustable-spacer)

Figure 2b. Turning the spacing adjustment knob on a Rainin XLS Adjustable Spacer pipette to accommodate plate formats or narrower spacing formats.

### Sample/assay specific requirements

Nontraditional, repeated or sequential pipetting can benefit from electronic pipettes since they can be used for repeat dispensing and can be programmed for specific pipetting protocols. Because the microprocessor eliminates human error and variability in moving the piston, electronic pipettes produce more consistent data than manual pipettes. This is especially noticeable with data requiring serial dilutions, where pipetting errors can be compounded, and with applications requiring amplification, such as qPCR.

#### Electronic pipettes can benefit

---

- Repeat or sequential pipetting
- Complex or repetitive protocols
- Applications requiring high levels of accuracy (e.g., qPCR, next-generation sequencing)



► [www.mt.com/electronic-pipettes](http://www.mt.com/electronic-pipettes)

Figure 3. Rainin E4 XLS+ electronic single channel pipette.

Every assay and sample has unique properties that can pose challenges. For example, for genomics applications, always use filter tips to minimize the effects of DNA or RNA contamination of the sample or the pipette. Filters block aerosols from the liquid sample from contaminating the shaft, and subsequently contaminating later samples. Filters can also help protect against microbial contamination, internal corrosion and salt deposits.

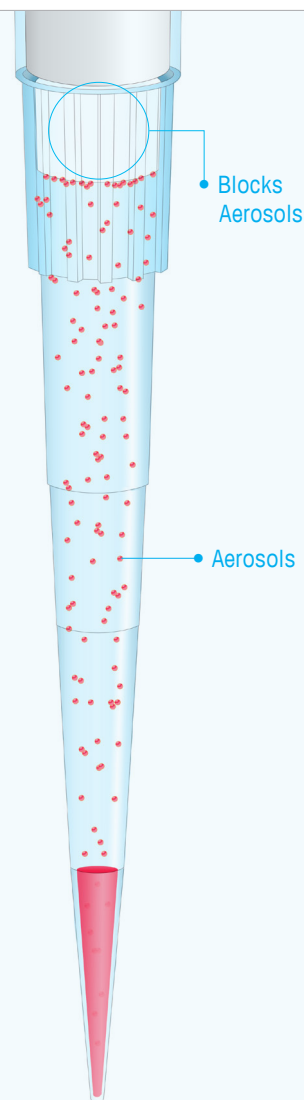
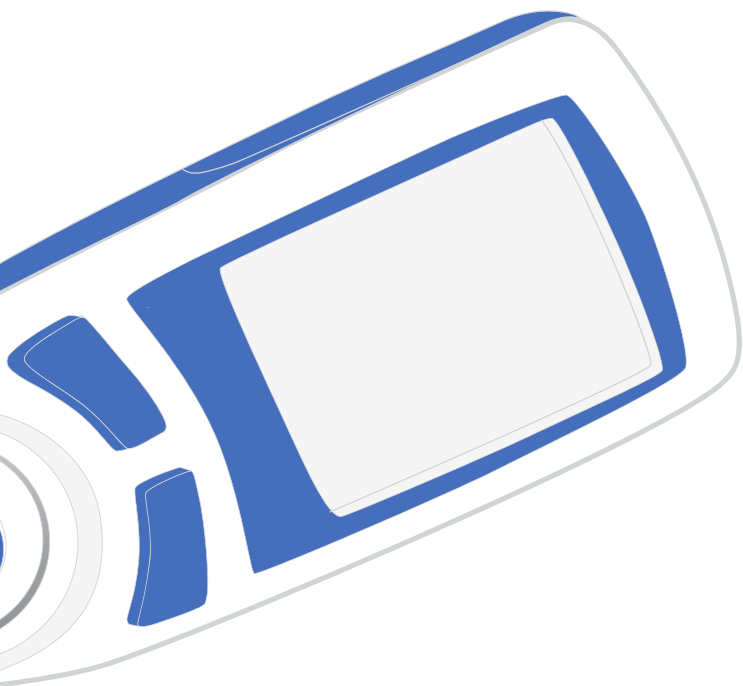

#### Filter pipette tips

Blocks aerosols and contaminants from entering the shaft of the pipette

► [www.mt.com/filter-tips](http://www.mt.com/filter-tips)

# Pipette Selection



---

## Pipette Selection

Different types of pipetting tools are available to help achieve optimal results and greater productivity, and at the same time provide additional benefits, such as improved ergonomic features and better functionality for a given application. There are two major types of micropipettes: air displacement and positive displacement. Both types determine the volume of liquid dispensed by using the diameter of the piston and length of the piston stroke.

## Air Displacement Pipettes

Air displacement pipettes are the most common pipetting instruments found in the lab. These pipettes operate by placing the end of the tip into the liquid sample, then releasing the plunger button. A partial vacuum is created when the pipette piston is moved up within the pipette body, and the liquid sample moves up inside the tip to fill the void of the selected volume created by the partial vacuum.

### Air displacement pipettes

- Extremely accurate with aqueous solutions
- Recommended for standard applications
- Technique dependent

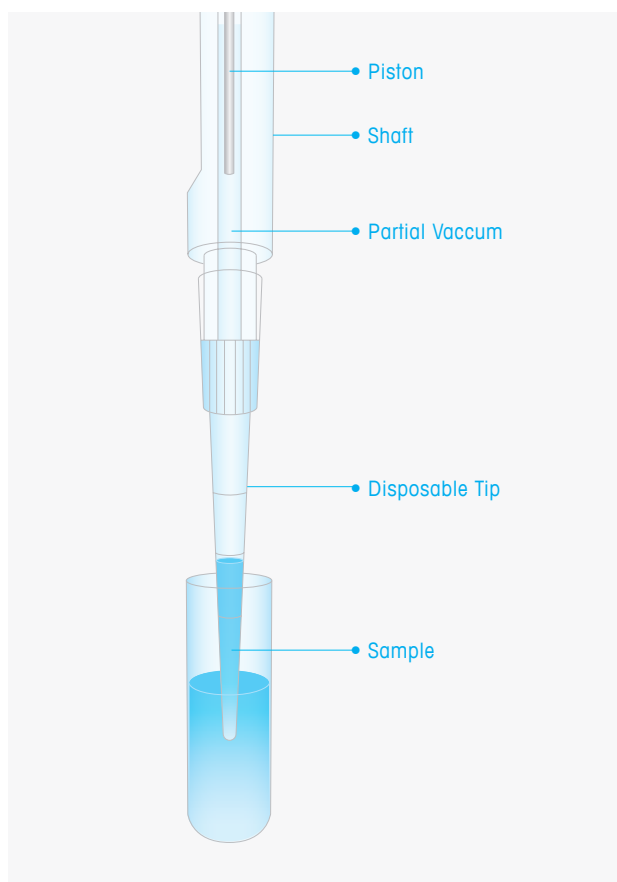

[www.mt.com/pipettes](http://www.mt.com/pipettes)

Figure 4. Air displacement pipette.



## Pipetting Cycle and Technique

### The pipetting cycle

When using any air displacement pipette, the pipetting cycle consists of four major steps:

1. Tip loading
2. Liquid aspiration (depress, hold and release plunger)
3. Liquid dispense/blowout (depress, hold and release plunger)
4. Tip ejection

This cycle is repeated several times when dispensing any type of liquid. All manual air displacement pipettes use the same pipetting cycle for dispensing liquids. The desired volume is set to be dispensed (micrometer), and the plunger button is pressed/released at a steady pace to specific positions — “first” and “second” stops (also known as “neutral” and “blowout” respectively). The first stop allows for liquids to be aspirated and/or dispensed while the second stop controls the blowout onto a designated vessel.

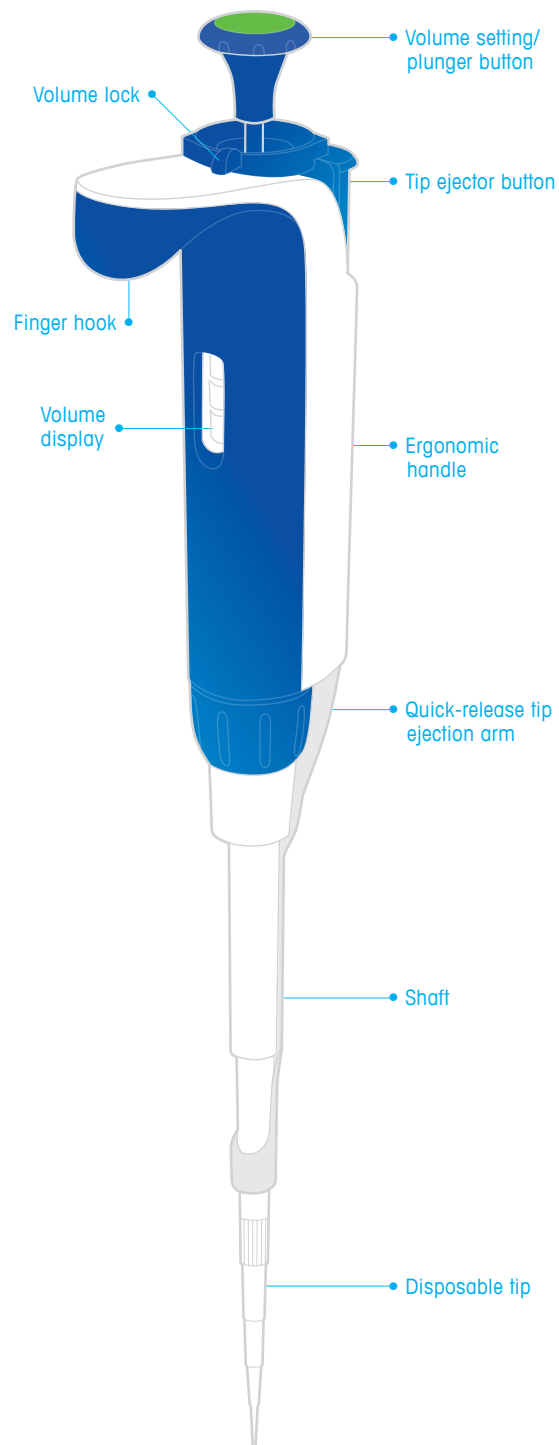
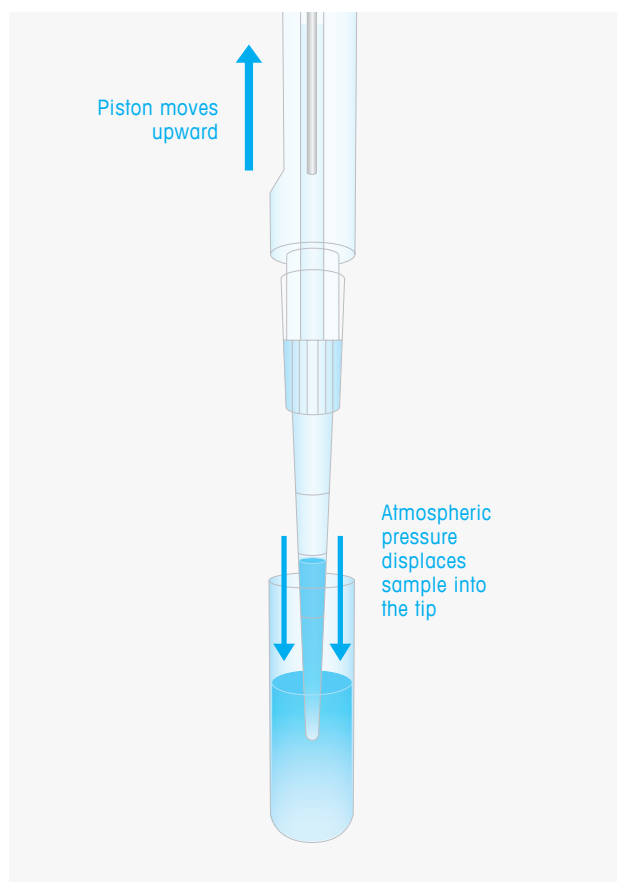

Figure 5. Air displacement pipette operation.

### Pipetting technique

Pipetting technique is arguably one of the most important factors in delivering accurate volumes, yet it is often overlooked in the process. Poor training, wrong assumptions and lack of knowledge of the nature of the sample greatly affect experimental results and reproducibility.

There are two different yet powerful techniques when using air displacement pipettes: forward pipetting and reverse pipetting. Each use the same pipetting cycle, but there are subtle variations in some of the steps. For application or use, the biggest difference in these two techniques depends on the nature of the sample and the temperature which the protocol needs to be carried out. Forward technique can deliver volumes accurately when pipetting aqueous solutions, while reverse technique is highly recommended when dealing with challenging liquids (e.g., viscous, dense).

The main difference between forward versus reverse pipetting is in the first two steps in the pipetting cycle (i.e., liquid aspiration). While executing forward technique, the plunger is pressed to the first stop. With reverse technique, the plunger is pressed all the way to the second stop.

Correct pipetting technique is critical to achieving high accuracy. It is widely accepted, and proven, that results from using air displacement pipettes are technique dependent.

### Forward Pipetting

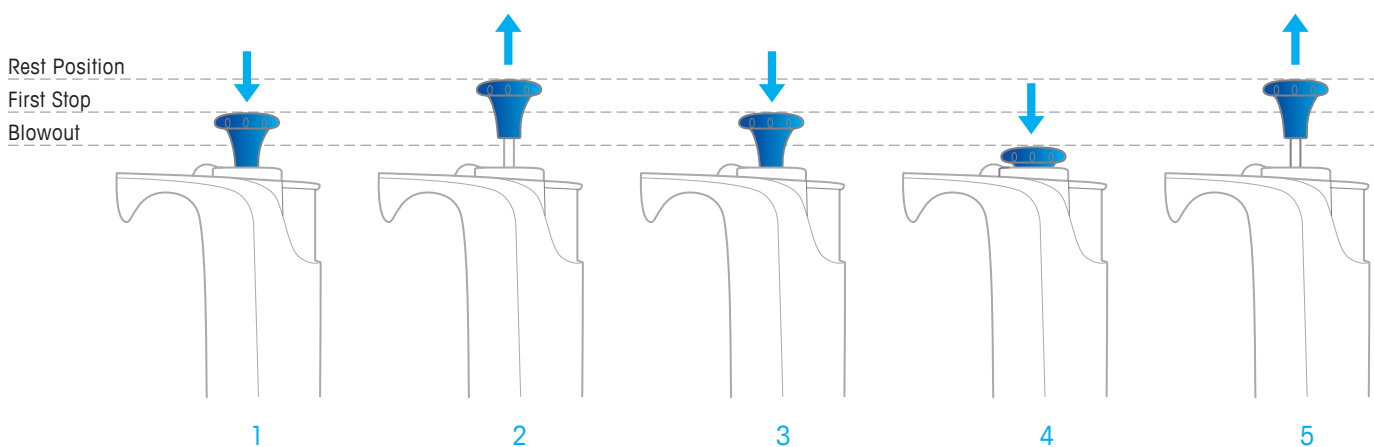

Figure 6a

Figure 6a and 6b. Forward and reverse pipetting techniques.

In reverse pipetting, pressing all the way to the second stop allows the pipette to aspirate extra "residual" volume, that is not included in the final dispense.

### Reverse Pipetting

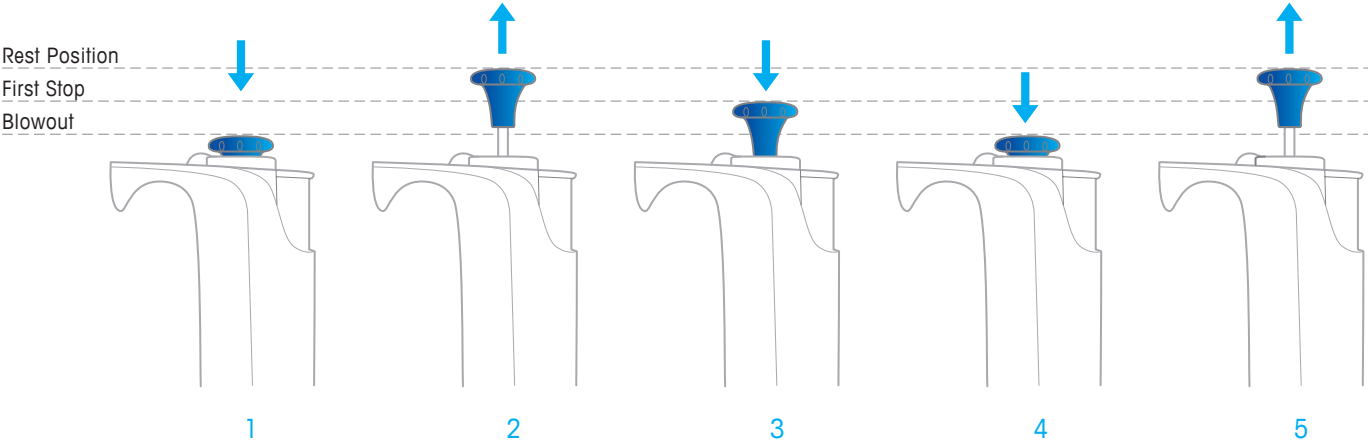
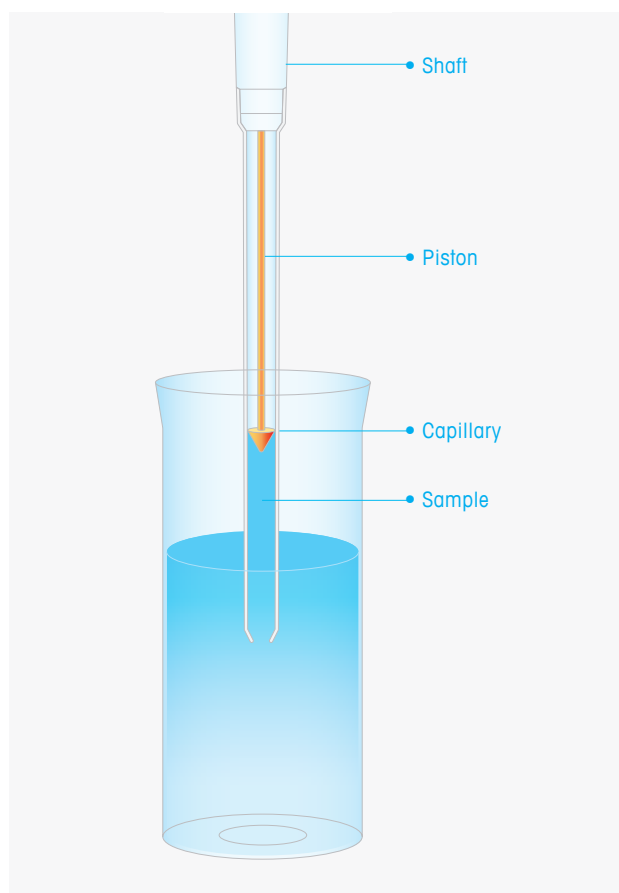

Figure 6b

## Positive Displacement Pipettes

While not as common as air displacement pipettes, positive displacement pipettes are frequently seen in laboratory settings. These pipettes use a disposable piston and capillary system to make a physical void of the selected volume. The piston is in direct contact with the sample. When the piston is moved upward the sample is drawn into the capillary. Positive displacement pipettes provide high accuracy when pipetting aqueous solutions, but are generally recommended for use with viscous, dense, volatile and corrosive solutions. The disposable capillaries and pistons used with a positive displacement pipette are more expensive compared to disposable air displacement pipette tips, so air displacement pipettes are recommended when they will yield the same results.



Positive displacement pipettes

- Extremely accurate with most solutions
- Recommended for viscous, dense, volatile or corrosive liquids



[www.mt.com/Pos-D](http://www.mt.com/Pos-D)

Figure 7. Positive displacement pipette.

---

## Sample Properties

### Sample type

Certain types of pipettes are better suited than others for different sample types. For instance, viscous samples may require a different technique or pipette to achieve good accuracy – small random errors (precision) and/or low systematic errors (trueness) – in one's experiments.

### Sample viscosity

Sample viscosity often adversely affects the ability of an air displacement pipette and tip to fully aspirate and discharge the sample during pipetting. This problem can be further compounded when pipetting liquids that interact hydrophobically with the polypropylene tip surface.

### Aqueous liquids

The composition and properties of liquids influence pipetting accuracy. Three physical mechanisms that determine the physical properties of aqueous liquids are:

- Surface tension
- Cohesion
- Adhesion

Surface tension is the tendency of liquid to coalesce into a shape exhibiting minimal surface area. Cohesion is a property of the molecules forming the liquid that establishes the physical structure of the liquid, allowing it to resist fragmentation when subjected to various physical forces. Adhesion is the tendency of liquids to interact with the surface upon which the liquid rests.

The presence of surface tension and cohesion within aqueous samples are directly attributable to hydrogen-bonding. Adhesion may be attributable to hydrophobic, electrostatic or other types of interactions.

Other liquid types, both organic and inorganic, may also exhibit significant amounts of both cohesion and surface tension. Cohesion and surface tension generally assist with the movement of liquids during aspiration and dispensing, facilitating optimal pipetting accuracy. Adhesion generally retards liquid movement and has an adverse effect upon pipetting accuracy. Liquids with reduced cohesion and surface tension and those exhibiting adhesion, will generally exhibit greater pipetting inaccuracy.

Many additives will dramatically reduce hydrogen-bonding in aqueous liquids and can adversely affect pipetting accuracy. These include alcohols and other water-soluble organics, surfactants, fatty acids and glycols.

### Volatile organic liquids

Compared to aqueous liquids, organic liquids often have lower surface tension and may also be volatile. Volatile organic liquids exhibit a high vapor pressure at ordinary room temperature. This high vapor pressure results from a low boiling point, which causes large numbers of molecules to evaporate from the liquid and enter the surrounding air, leading to their characteristic “organic” odor. The discharge of organic molecules into a closed system, such as the airspace between the top of a liquid column in a tip and the piston within a pipette, will usually lead to an increase in pressure. This increased pressure, coupled with diminished surface tension and low viscosity, will often cause volatile organic liquids to dribble out of the end of a pipette tip. This loss of liquid results in a significant decrease in pipetting accuracy, since the transferred liquid volume now differs substantially from the preset volume on the pipette.

The following tables provide more information related to classification of liquids based on physical characteristics, common examples, the recommended pipetting technique and suggested instrument solution for some of these common types of liquids.

Type of Sample	Recommended Pipetting Technique or Pipette Type	Typical Examples
<b>Aqueous</b>	<b>Forward Pipetting</b>	All water-based liquids
		DI water
		Buffers (PBS, Acetate, Citric, MOPS, MES, Phosphate)
		Diluted solutions (protein, antibody)
<b>Viscous (dense)</b>	<b>Reverse Pipetting</b>	Glycerol (10-100%)
		Protein solution (native, recombinant)
		Antibody solution (monoclonal, polyclonal)
		Nucleic acid solution (RNA, DNA, oligonucleotides)
		Detergents (SDS, Tween, NP40)
		Biofluids (blood, serum, plasma, CSF)
		Concentrated inorganic acids ([HCl], [H <sub>2</sub> SO <sub>4</sub> ])
		Concentrated inorganic bases ([NaOH]*, [KOH])
<b>Volatile (organic solvents)</b>	<b>Positive Displacement Pipette</b>	Acetone
		Isopropanol
		Methanol
		Chloroform
		Ethanol

**Table 2. Recommended pipetting technique or pipette type for handling different sample types.**

Neither of the two air displacement pipetting techniques are recommended when dealing with liquids with high volatility or high vapor pressure. Poor reproducibility can be expected with air displacement pipettes in such cases.

Type of Liquid	Temperature	Volume Range	Pipetting System	Air Displacement Model	Pipetting Technique	Positive Displacement Model
<b>Viscous Liquids</b>	Ambient and Non-Ambient	Very High 20 – 50 mL	Manual	NA	NA	AutoRepS
			Electronic	NA	NA	NanoRep
	Ambient and Non-Ambient	High 1 – 20 mL	Manual	Pipet-Lite XLS+	Reverse	AutoRepS
			Electronic	E4 XLS+	Reverse	NanoRep
	Ambient and Non-Ambient	Medium 200 – 1000 µL	Manual	Pipet-Lite XLS+	Reverse	Pos-D / AutoRepS
			Electronic	E4 XLS+	Reverse	NanoRep
	Ambient and Non-Ambient	Low 10 – 200 µL	Manual	Pipet-Lite XLS+	Reverse	Pos-D / AutoRepS
			Electronic	E4 XLS+	Reverse	NanoRep
	Ambient and Non-Ambient	Micro < 10 µL	Manual	Pipet-Lite XLS+	Reverse	Pos-D / AutoRepS
			Electronic	E4 XLS+	Reverse	NanoRep
<b>Aqueous Solutions</b>	Ambient	Very High 20 – 50 mL	Manual	NA	NA	AutoRepS
			Electronic	NA	NA	NanoRep
	Ambient	High 1 – 20 mL	Manual	Pipet-Lite XLS+	Forward	AutoRepS
			Electronic	E4 XLS+	Forward	NanoRep
	Ambient	Medium 200 – 1000 µL	Manual	Pipet-Lite XLS+	Forward	Pos-D / AutoRepS
			Electronic	E4 XLS+	Forward	NanoRep
	Ambient	Low 10 – 200 µL	Manual	Pipet-Lite XLS+	Forward	Pos-D / AutoRepS
			Electronic	E4 XLS+	Forward	NanoRep
	Ambient	Micro < 10 µL	Manual	Pipet-Lite XLS+	Forward	Pos-D / AutoRepS
			Electronic	E4 XLS+	Forward	NanoRep
<b>Volatile or Organic Solvents</b>	Ambient and Non-Ambient	(Very) High 1 – 50 mL	Manual	NR	NA	AutoRepS
			Electronic	NR	NA	NanoRep
	Ambient and Non-Ambient	Medium 200 – 1000 µL	Manual	NR	NA	Pos-D / AutoRepS
			Electronic	NR	NA	NanoRep
	Ambient and Non-Ambient	Low 10 – 200 µL	Manual	NR	NA	Pos-D / AutoRepS
			Electronic	NR	NA	NanoRep
	Ambient and Non-Ambient	Micro < 10 µL	Manual	NR	NA	Pos-D / AutoRepS
			Electronic	NR	NA	NanoRep

**Table 3. Recommended Rainin pipetting solutions and techniques for handling different sample types.**

NR: Not recommended      NA: Not applicable

## Pipettes

### Manual single channel pipettes

Compact and ubiquitous, single channel pipettes are arguably the most used instrument in any life science facility. Even though new technology and techniques have facilitated groundbreaking discoveries, there is always the need for single channel pipettes at any given point. Furthermore, the design and size principles of modern pipettes have stayed somehow unchanged (modern pipettes were invented in 1957) and survived the latest trends in assay development. Very few instruments in life science are as versatile. Almost any subdivision in life science uses single channel pipettes – from basic research to the latest trends in biotechnology, molecular biology, genomics, gene therapy and immunotherapy – and are compatible with any assay format and vessels, from single cuvettes, vials, centrifuge tubes to culture dishes, flasks and multi-well plate formats (up to 384-well microplates).

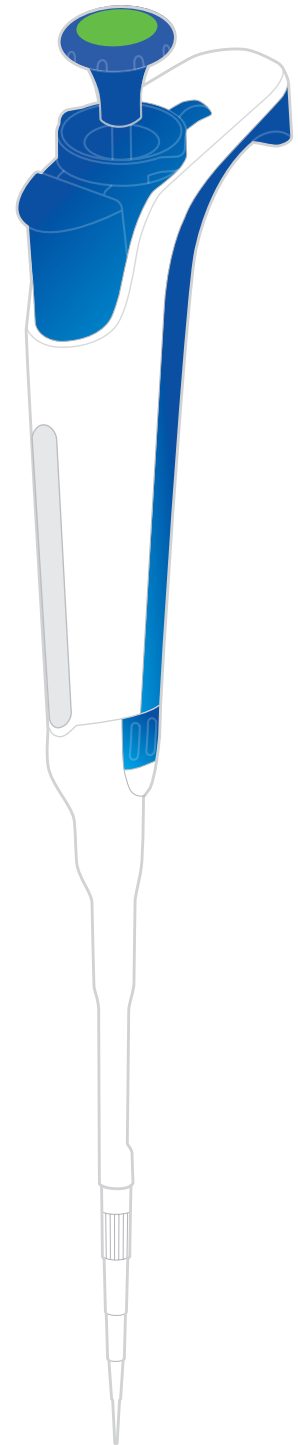

► [www.mt.com/manual-pipettes](http://www.mt.com/manual-pipettes)

---



---

## Electronic single channel pipettes

Electronic pipettes have been available since the mid-1980s. In electronic air displacement pipettes, aspiration and dispensing are controlled by a microprocessor and are initiated by pressing a trigger, rather than by using the thumb to press or release a plunger button. Most users will find using an electronic pipette achieves more consistent sample pick-up and dispensing, improved accuracy and repeatability, and virtually eliminates user-to-user variability.

Modern electronic pipettes should be simple to operate with a good user interface and a color screen. These pipettes are versatile and useful for accurately performing intricate tasks such as:

- Repeat dispensing
- Controlled titrations
- Serial dilutions
- Aspirating liquids from delicate samples
- Measuring unknown sample volumes

With an electronic pipette it is easy to program repeated movement of the piston to mix two solutions inside the tip. Electronic pipettes with aspiration and dispensing speed controls can be used to pipette a wide variety of liquids. The fastest speeds are ideal for pipetting aqueous samples while slower speeds are advised for viscous, foaming or shear-sensitive samples.

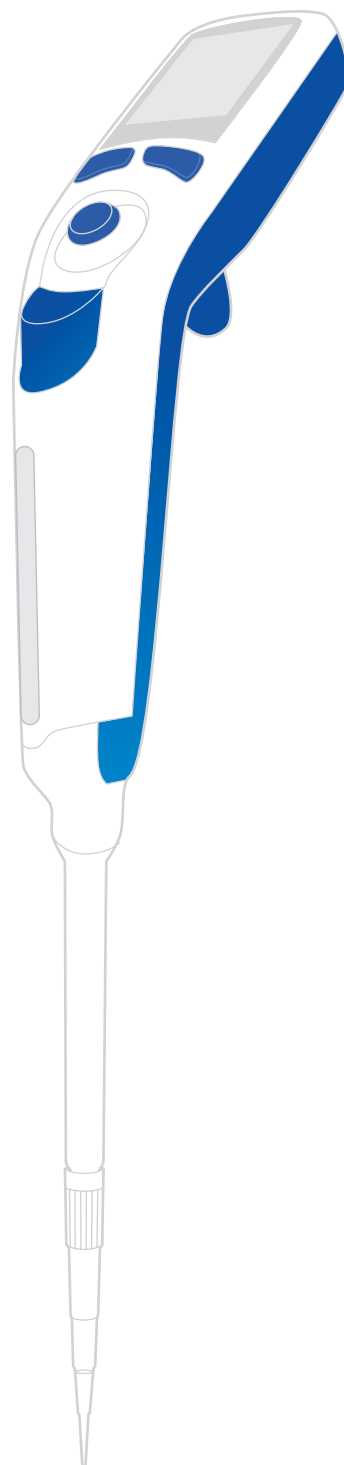

► [www.mt.com/electronic-pipettes](http://www.mt.com/electronic-pipettes)

### **Multichannel pipettes**

Multichannel pipettes are ideal for high-throughput applications, including 96-well-plate ELISA work and PCR for DNA synthesis. Advanced-design multichannel pipettes, 8- and 12-channel models, load tips quickly and securely with consistent sample pickup across all channels. Adjustable spacer models allow the tip spacing to be set by the user for dispensing, such as from 96-well plates to tube racks or to 24-well plates.

The number of 384-well applications has grown significantly in the last 20 years. Traditionally, these protocols are carried out using complex automated systems (robotic liquid-handling platforms), but the recent introduction of 16- and 24-multichannel pipettes has allowed researchers to set up 384-well plates manually. This is particularly useful in cases where a proof of concept or a small number of samples needs to be tested, or there is no access to expensive robotic instruments.

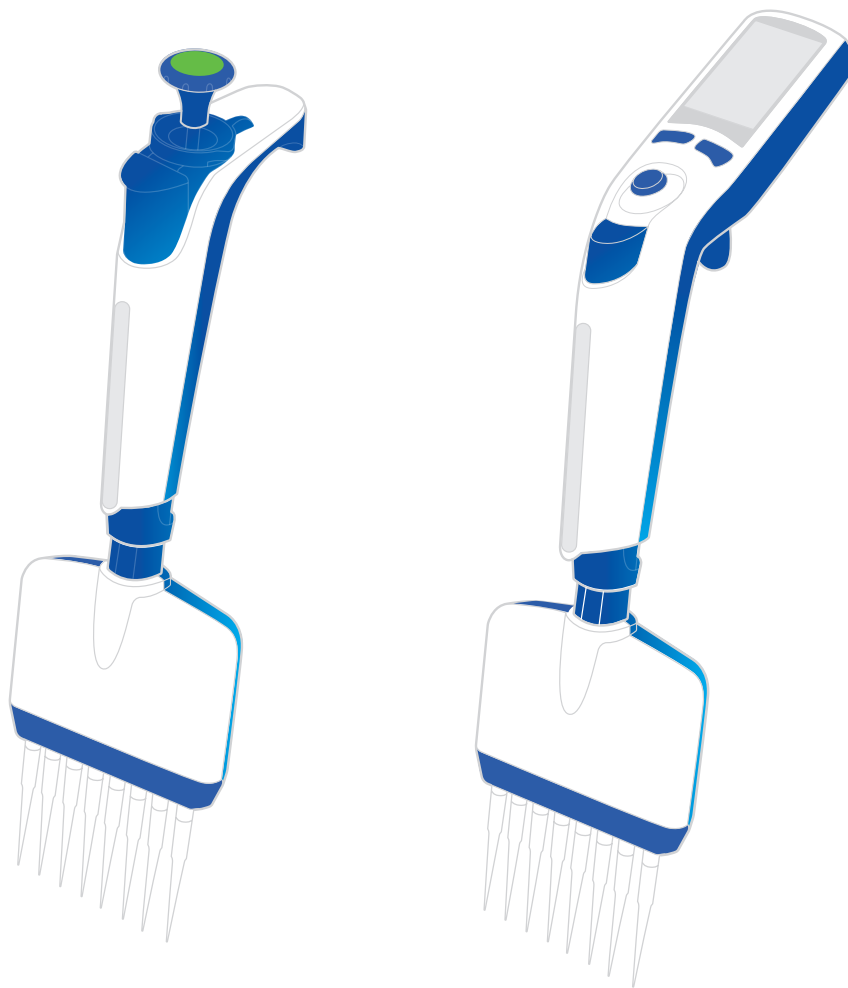

► [www.mt.com/multichannel-pipettes](http://www.mt.com/multichannel-pipettes)

## Adjustable spacer pipettes

Microplates allow researchers to process and analyze multiple samples simultaneously. Microplates can have 6, 12, 24, 48, 96, 384 or 1536 wells arranged in a rectangular matrix. The plate itself follows standard dimensions; however, well diameter is a function of the total number of wells per plate (e.g. the diameter between the wells of a 24-well plate is larger than the diameter between the wells of a 96-well plate). Transferring samples from one microplate dimension to a different microplate dimension (e.g., 24-well to 96-well) or between different-sized vessel formats (tube to tube, tube to plate or any other variation) can be challenging and time consuming due to the differences in sample distance.

Adjustable spacer pipettes are special types of 6- or 8-multichannel pipettes in which the distance between nozzles can be adjusted to accommodate different sample distances. This adjustment can vary between 9 mm (distance between two wells of a 96-well plate) to 19 mm (distance between two wells of a 24-well plate) to support quick and efficient sample transfer.

Rainin multichannel and adjustable spacer pipettes are available in manual and electronic formats in a wide range of volumes.

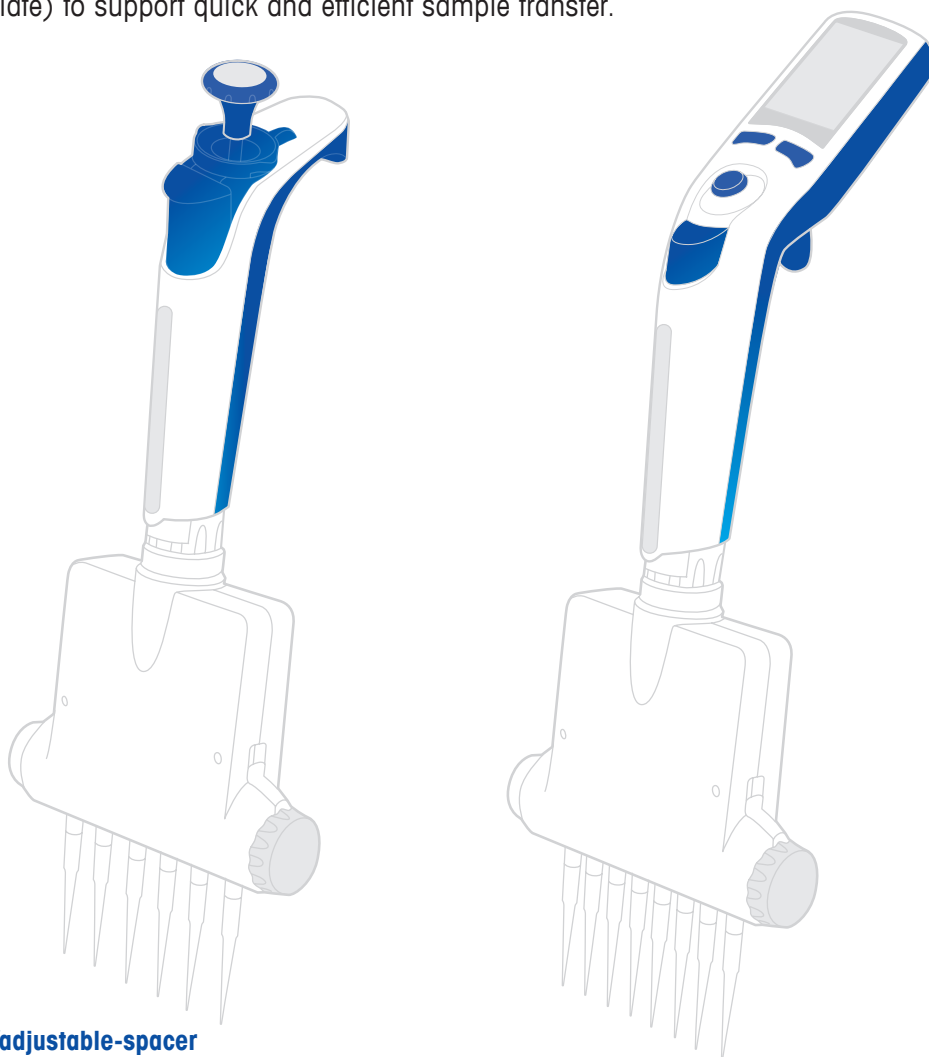

► [www.mt.com/adjustable-spacer](http://www.mt.com/adjustable-spacer)

### Higher-throughput pipetting systems

Pipetting systems that aspirate and dispense 96 wells at once are ideal for fast, efficient multi-well plate workflows. Until recently, expensive robotic systems were the only way to achieve 96- or 384-well or full plate pipetting. Semi-automated liquid-handling instruments offer better reproducibility by eliminating user variability when aspirating and dispensing. Overall, semi-automated systems streamline application workflows, including plate washes, plate replications and complex protocols.

Complex protocols suited for higher-throughput pipetting systems include

- Genomics (PCR, qPCR, next-generation sequencing)
- Proteomics
- Cell-based assays (chemotaxis, cell viability, cell proliferation, cytotoxicity assays)
- Antibody-based assays (ELISAs, hybridoma generation, antibody selection/discovery)
- Functional assays (enzymatic reactions, EC<sub>50</sub>, MIC)

	Rainin Liquidator 96	Rainin BenchSmart 96
	Manual	Electronic
Head Movement	Manual	Manual
Tray Movement	Manual	Manual
Volume Range Heads	Fixed head	Exchangeable head
Tip Loading	Manual	Electro-mechanical
Tip Ejection	Manual	Electro-mechanical
20 µL	Yes	Yes
200 µL	Yes	Yes
1000 µL	No	Yes
Asp/Dis Speed	Manual	Electronic

Rainin offers two higher-throughput systems: Liquidator 96™ and BenchSmart 96™

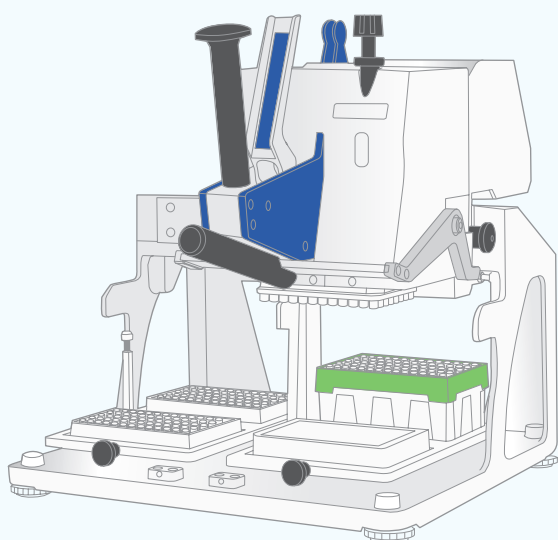

### Liquidator 96

A fully manual benchtop pipetting system that requires no electricity, programming or operator training. Simplifies and streamlines 96-well and 384-well pipetting and can be used in the lab or in the field.

► [www.mt.com/Liquidator96](http://www.mt.com/Liquidator96)

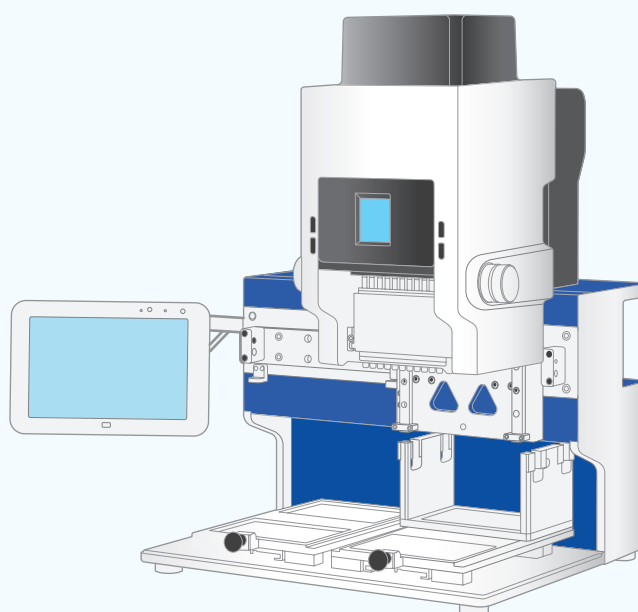

### BenchSmart 96

An easy-to-use and programmable electronic pipetting system. Readily design, save and retrieve custom protocols from one-step procedures to multistep experiments. Perform complex pipetting tasks, including basic pipetting, fixed-volume pipetting, sequenced pipetting, dilution inside of a tip and reverse pipetting (critical when dealing with viscous, dense or volatile liquids).

► [www.mt.com/BenchSmart96](http://www.mt.com/BenchSmart96)

## Specialty Pipettes

Other types of pipettes or liquid-handling devices are less common than air displacement pipettes, but are often preferred by researchers for their specific design and purpose.

### Positive displacement pipettes

Positive displacement pipettes use a disposable piston and capillary tip system to make a physical void of the selected volume. The piston comes into direct contact with the sample, and when the piston is moved upward, the sample is drawn into the capillary. This system prevents cross-contamination of the pipette by the sample, as a new piston and capillary tip is used for each sample.

Positive displacement pipettes are ideal for use with solutions that are viscous (blood, serum, plasma, CSF, high-protein concentration samples, antibodies, glycerol); dense (glycerol, highly concentrated detergents, SDS), volatile (ethanol, methanol, isopropanol) or corrosive (inorganic acids and bases such as HCl, H<sub>2</sub>SO<sub>4</sub>, KOH, NaOH).



The Rainin Pos-D is a good solution for pipetting difficult liquids such as dense, viscous and volatile samples.

► [www.mt.com/Pos-D](http://www.mt.com/Pos-D)

---

## Repeater pipettes

With their syringe and built-in piston, repeater pipettes work on the positive displacement principle. They are designed to draw in a large volume of liquid sample, which is then dispensed in multiple, equal aliquots. They are available in electronic or manual versions and use disposable syringes in a wide range of volumes.

Repeater pipettes use a positive displacement system to repeat-dispense aqueous, viscous, volatile or dense liquids.

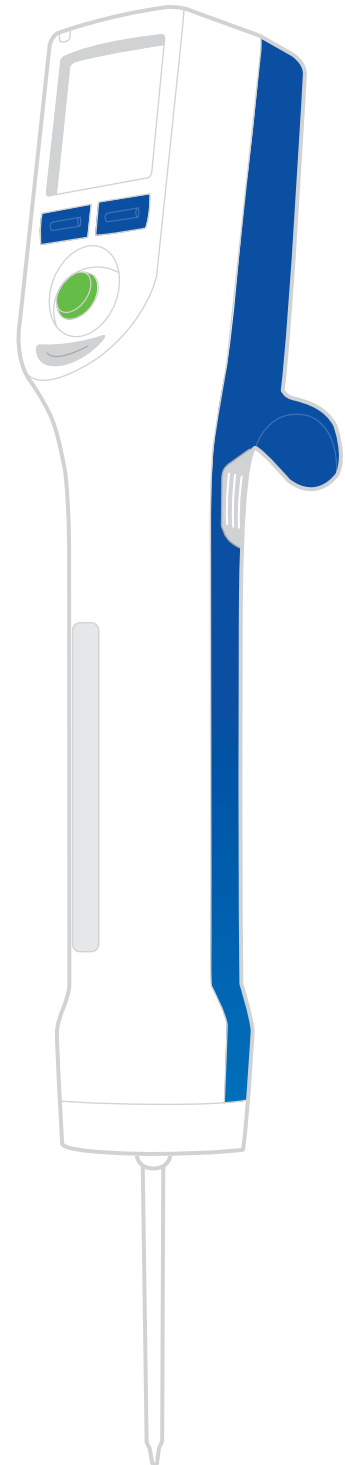

### Bottle-top dispensers

Some laboratory liquids by their nature (e.g., corrosives or toxic liquids) are best left in place in fume hoods or biosafety cabinets, and not moved around the lab. A bottle-top dispenser is useful to safely transfer relatively small quantities of these liquids. The dispenser operates by pump action, and newer versions provide accurate and safe delivery of hazardous liquids in volumes up to 50 mL.

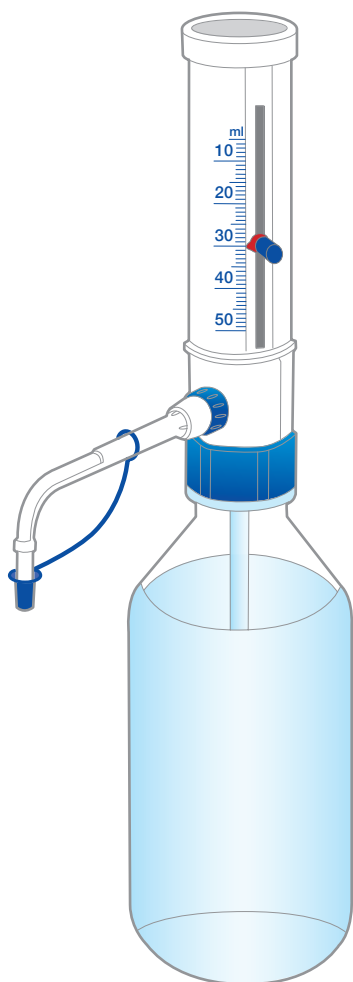

### Pipette controllers

Used primarily for transferring large volumes (25-100 mL), pipette controllers are electronic or manual devices that provide suction for glass or plastic serological pipettes. With electronic controllers, the pipette is attached to the soft "nose" and the user presses a button on the pipette controller to create a partial vacuum inside the glass or plastic pipette. The partial vacuum is displaced by the liquid under atmospheric pressure. The liquid sample is transferred to another vessel by pressing a trigger button or by gravity. The simplest versions employ a soft flexible bulb that is manually squeezed and released to create and control the partial vacuum.

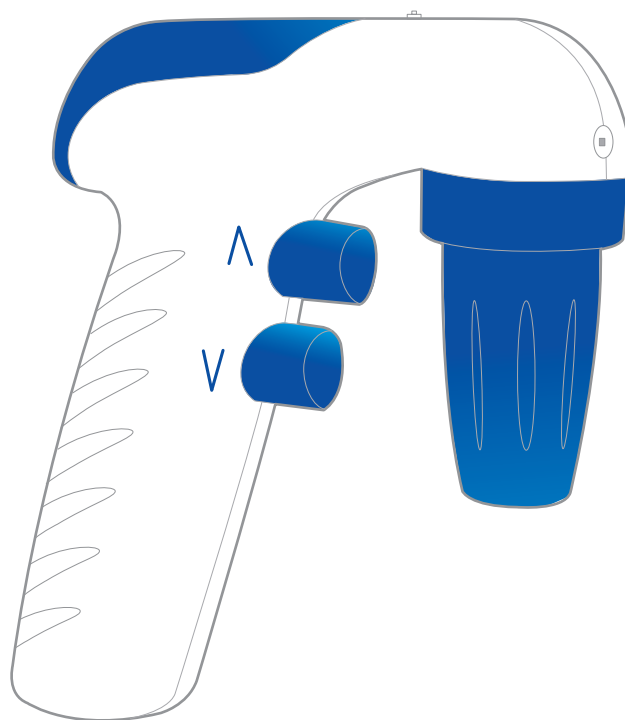

► [www.mt.com/Disp-X](http://www.mt.com/Disp-X)

► [www.mt.com/Pipet-X](http://www.mt.com/Pipet-X)



## Liquid aspirators

Removing liquid waste from cell culture, supernatant or nucleic acid extractions can be a tedious and repetitive routine for many laboratories. For small volumes, manual pipettes can accomplish the task. However with larger volumes or sample numbers, aspiration using a vacuum source can be more efficient at waste removal. Liquid aspirators are compact systems that use a built-in vacuum pump to collect liquid waste into a collection bottle, which is disposed of when the bottle becomes full. The compact footprint of these aspirators makes it portable and easy to fit into biosafety cabinets.



The Rainin QuickFlow aspirator is portable, easy to use and includes three adaptors (Pasteur, single channel and 8-channel) for flexibility across applications. Variable speed settings allow for suction control, and the robust, non-contact liquid level sensor prevents waste overflow and contamination.

► [www.mt.com/QuickFlow](http://www.mt.com/QuickFlow)



---

## **Pipette Tip Selection**

The performance and accuracy of even the best pipette can be significantly compromised by using poor quality or ill-fitting pipette tips. The pipette and pipette tip work as a system to transfer and deliver liquids with accuracy and precision. When proper pipetting techniques are applied, tips offer guaranteed performance of specified accuracy, provided the manufacturer's recommended tips are used.

### Pipette Tips

Polypropylene possesses many desirable physical properties, which not only allow it to be molded into finely-tapered thin-walled tips, but capable of enduring the various processes and challenges associated with liquid transfer.

Pipette tips come in a variety of formats and sizes. Identifying the proper tip for each laboratory application is critical to the success and reproducibility of the results. While standard tip types can be used for multiple applications, the degree of performance will vary depending on sample properties. Specialty tips are designed to support specialized applications, workflows or liquids.

It is highly recommended to consider the pipette and its manufacturer-recommended tip as a system, and not as two independent components. Pipette tips advertised for use with all brands of pipettes often exhibit compromises in fit or design since they are intended to fit a wide range of pipette models.

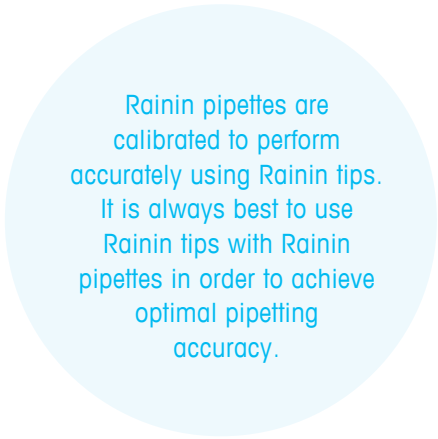

Rainin pipettes are calibrated to perform accurately using Rainin tips. It is always best to use Rainin tips with Rainin pipettes in order to achieve optimal pipetting accuracy.

Rainin has carefully selected a particular type of polypropylene, which embodies an optimal set of characteristics for pipetting:

- Excellent molding properties
- Broad chemical resistance
- High hydrophobicity
- Autoclavable
- Good clarity
- Suppleness
- High purity and inertness
- High batch-to-batch consistency
- Low metal and leachables content
- Additive-free
- Amenable to gamma and e-beam sterilization

## Non-sterile

Non-sterile pipette tips are commonly used in laboratory applications where sterility is not important for the experiment. When sterility is required, non-sterile tips may be autoclaved and stored for future use. For example, non-sterile tips can be purchased in bulk, racked, then autoclaved to prevent contamination.

## Sterilized

Sterilized pipette tips offer the convenience and assurance that the tips are free of viable microorganisms such as bacteria, viruses and yeast. Sterile tips can be purchased in racked boxes or as refill options.

Rainin employs gamma irradiation to sterilize all tips. A dose of 11.9-28 kGy is used to achieve complete sterility; this process was determined by carefully conducting bioburden studies for microbial load which results in the dose of ionizing radiation required to achieve full sterility.



► [www.mt.com/pipette-tips](http://www.mt.com/pipette-tips)

## Specialty Tips

### Filter

Filter tips are used to eliminate pipette cross-contamination or pipette contamination from aerosol particles generated during pipetting without producing any discernible difference in pipette performance. The use of filter tips to prevent DNA or RNA contamination (genomic applications, PCR) or pipetting volatile solutions is recommended to prevent potentially corrosive vapors from entering the pipette shaft and damaging the piston.

Rainin has demonstrated the ability of its filter tips to efficiently trap aerosol particles within a size range of 0.5-10  $\mu\text{m}$ .



► [www.mt.com/filter-tips](http://www.mt.com/filter-tips)

Tip filters prevent the movement of aerosolized particles into the pipette and are effective at preventing pipette contamination and potential sample cross-contamination. Rainin filters consist of polyethylene granules that have been sintered into a three-dimensional structure containing numerous pores and convoluted channels. These “tortuous path” filters block aerosol particles from the airstream, due to their mass and inertia, as they impact a channel wall within the interior of the filter.

Placing such a semi-solid structure between the sample liquid and the pipette during aspiration and dispensing will invariably impede air movement to some extent, resulting in areas of slight, yet detectable, backpressure. This backpressure forms between the distal face of the filter and the liquid column rising within the tip during aspiration. During dispensing, backpressure accumulates between the proximal face of the filter and the pipette interior.

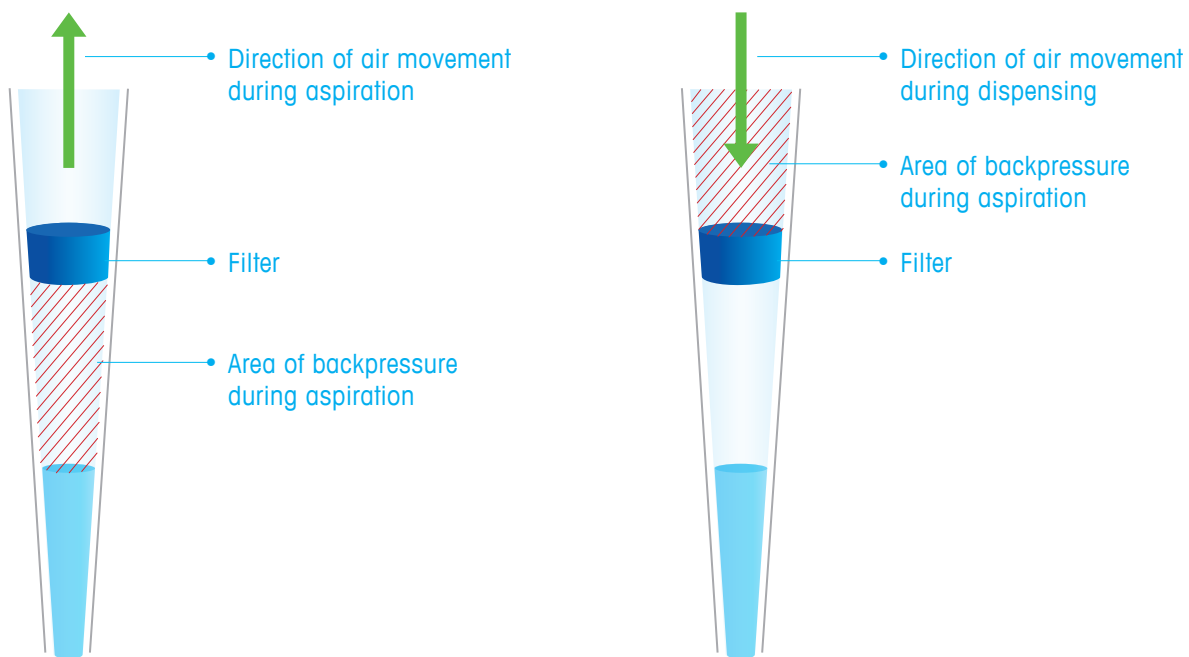

This backpressure reduces the force available to move the liquid sample into and out of the tip. If the reduction in force is substantial enough, insufficient volumes of liquid will be aspirated and dispensed, resulting in pipetting inaccuracy, often referred to as “systematic error”.

Figure 8. Areas of backpressure which form in response to the presence of a filter.

### Low retention

Low retention tips provide two key benefits compared to standard polypropylene tips. First, they facilitate maximum expulsion of sample liquid from the tip, regardless of the composition or physical characteristics of the liquid. This means that dispensing viscous and other recalcitrant liquids, such as liquids with reduced surface tension, will be optimized. Second, for labs that routinely pipette an array of different sample liquids, the low retention surface “normalizes” the movement of the liquids into and out of the tip. This means that the pipetting accuracies of liquids with diverse compositions and physical properties are brought into alignment, maintaining greater uniformity when a broad range of different liquids with diverse physical properties are routinely used within a particular lab environment.

Rainin low retention tips use an advanced fluoropolymer to create a highly repellent, “superhydrophobic” tip surface.

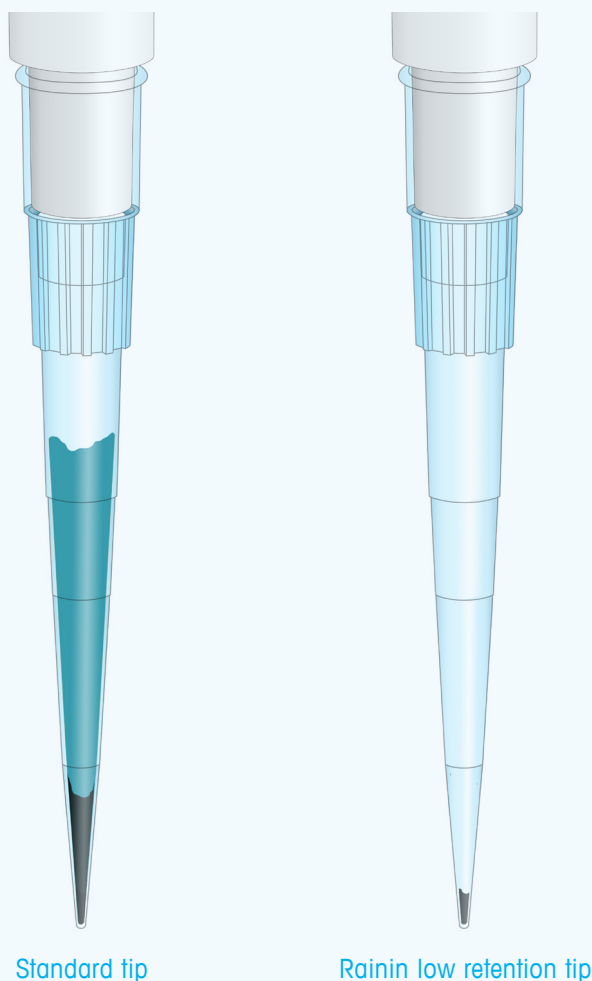

► [www.mt.com/low-retention-tips](http://www.mt.com/low-retention-tips)

**Figure 9.** Highly repellent surface of a Rainin low retention tip compared to a standard tip (250  $\mu$ L). There is significantly less residual blue food coloring remaining in the low retention tip after dispensing.



### Residual volume in standard vs. low retention tips (250 $\mu$ L)

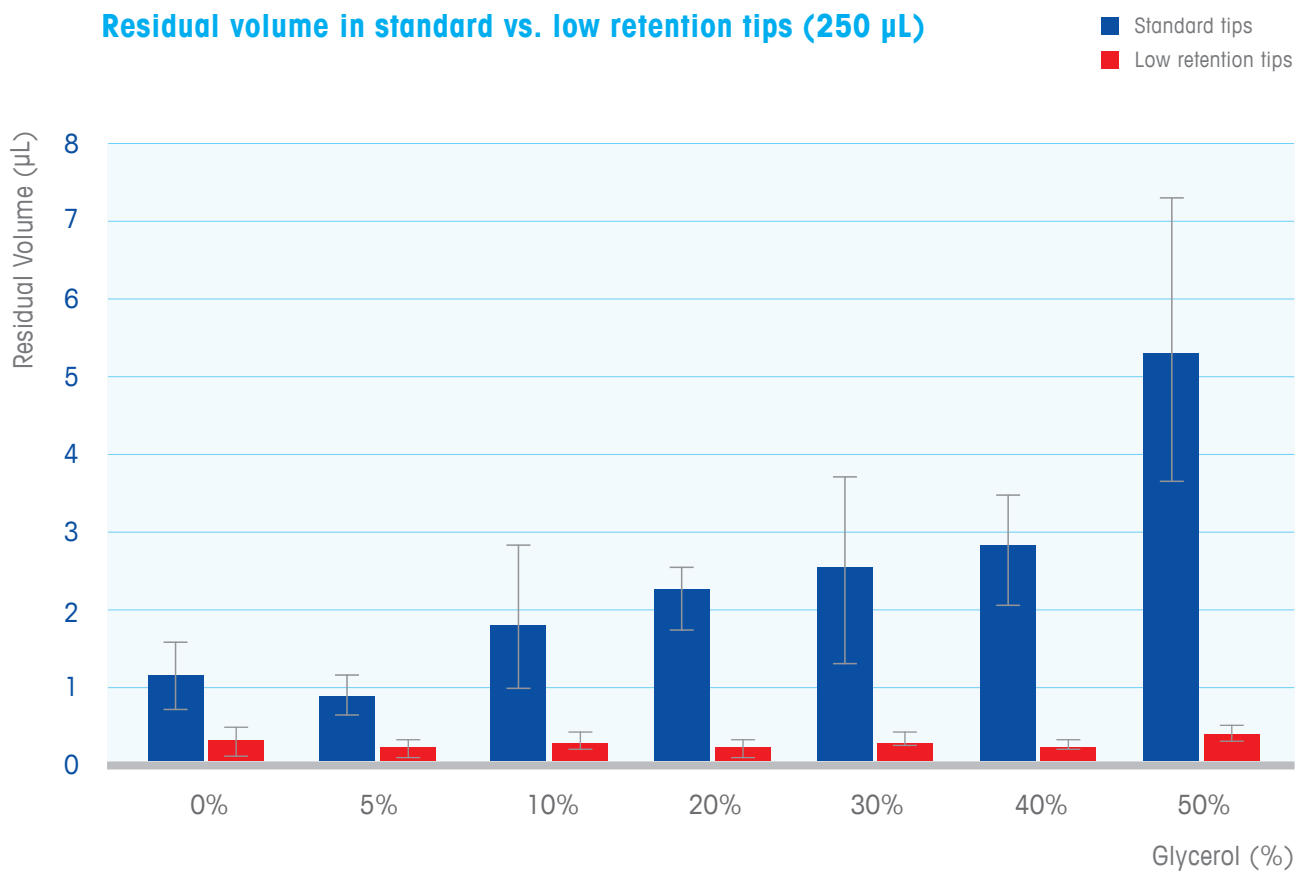

**Figure 10. Data indicates improved sample dispensing with low retention tips compared to standard tips when pipetting samples with increased viscosity (demonstrated by increased glycerol levels).** For reference, most thermostable DNA polymerases and many other enzymes are routinely suspended in buffers which contain 50% glycerol.

### Wide orifice

Wide orifice tips have an enlarged orifice to accommodate viscous liquids and liquids containing particulates, clumps of solid material or high molecular weight polymers. Wide orifice tips also reduce shear force and are recommended for use with delicate samples, such as cultured mammalian cells. Wide orifice tips are not certified for accuracy due to their modified design, but are recommended for enabling certain applications.

### Extended length

Extended length tips are much longer and somewhat narrower than standard length tips. These tips are designed to provide additional “reach” when pipetting. Extended length tips are not certified for accuracy due to their elongated geometry, but are recommended for retrieving samples from certain tall, narrow vessels, such as tubes and vials, which are not accessible by standard length tips.

### Shielded

Shielded tips have a protective collar that surrounds the pipette shaft and tip ejector, preventing cross-contamination with liquids. These tips can be used with a variety of tubes or deep well plates without the risk of the pipette shaft or ejector touching vessel walls and becoming contaminated.

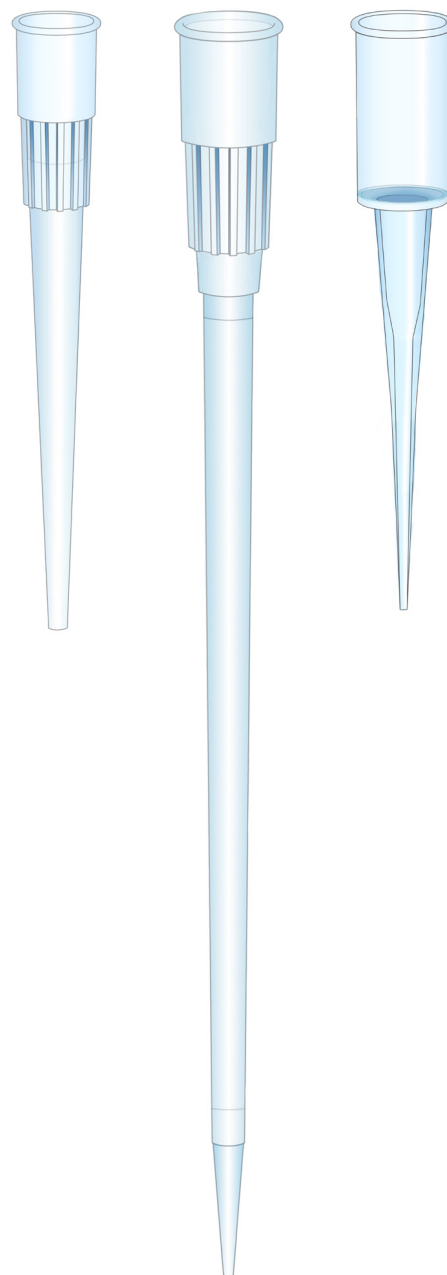

Rainin developed ShaftGard™ universal-fit 10 µL tips to prevent contamination of the end of the pipette when inserting the tip into vessels, such as microcentrifuge tubes.

► [www.mt.com/specialty-tips](http://www.mt.com/specialty-tips)

Figure 11a. Wide orifice, extended length and shielded tips.

## Gel loading

Gel loading tips are flexible, ultra-thin micro-capillary tips ideal for DNA sequencing and protein separation. Gel loading tips allow the dispensing of samples into thin wells in an electrophoretic slab gel apparatus or in sample recovery.

## Capillary piston

Capillary piston tips are designed to be used with positive displacement pipettes and are most effective with non-aqueous solutions that are dense, viscous or volatile, or for pipetting cold or warm aqueous solutions.

## Sample preparation tips

Sample preparation tips, with resins embedded in the narrow end of the tip, offer a convenient, low-cost method of purifying biomolecules. These sample preparation tips can produce high concentrations of purified protein, allowing many options for downstream functional assays.

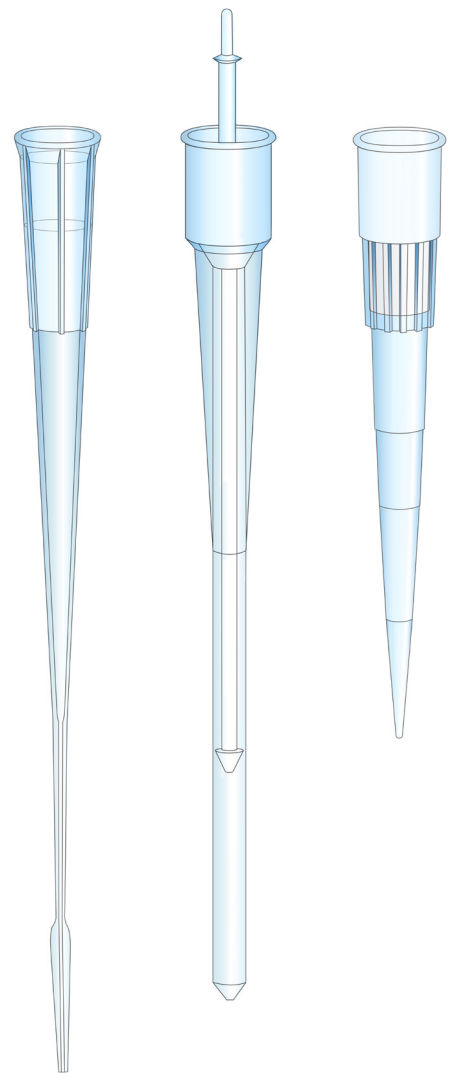

Capillary piston tips rely upon the movement of a piston within a capillary and generate greater force to deal with recalcitrant samples. The absence of an air gap also renders these tips a better choice for dealing with volatile organic liquids.

PureSpeed® sample preparation tips by Rainin can streamline many types of proteomic and genomic experiments including:

- Immunoprecipitation
- Chromatin immunoprecipitation (ChIP)
- Recombinant and native protein purification

► [www.mt.com/purespeed](http://www.mt.com/purespeed)

Figure 11b. Gel loading, capillary piston and filter tips.

### Tip Quality

#### **Absence of biological contaminants**

Researchers must have absolute confidence in the data they are generating. Any contaminant introduced into a sample or reaction can alter reaction conditions, influence the experimental outcome and affect data fidelity. It is critically important that pipette tips be free from the presence of detectable biological contaminants.

It should be noted that contaminants are molecules that may have a biological origin. They are not intended to be added during the manufacturing process and can negatively impact users' protocols, results and conclusions. Examples of contaminants include DNA, DNase, RNA, pyrogens, endotoxin and proteases. Many of these biomolecules will be present if the manufacturing and packaging processes do not take place in a clean-room environment. A good production facility will ensure all workers are fully gowned and wear hairnets, masks and gloves, and that the work environment has only filtered air in order to prevent any contamination by hair, aerosols or insects.

Certificates that support the testing of these contaminants should state the testing process and the sensitivity of the assay. Beware of certificates that claim a product to be "free of" a specific contaminant without describing the detection method or the sensitivity of detection, or do not provide any information or assurance of quality.

## Rainin BioClean Ultra

Rainin employs the most stringent, comprehensive quality testing for the broadest range of biological contaminants within the industry. Rainin is the only pipette manufacturer test for both protein and protease contamination. As a result, Rainin BioClean Ultra tips are designated as "proteomics qualified." This table shows the thoroughness and completeness of Rainin BioClean Ultra quality testing, compared to other major tip brands.



	Human DNA	Bacterial DNA	DNase	RNase	Endotoxin	Protein	Protease	ATP	PCR Inhibitors
<b>BioClean Ultra</b>	< 0.32 pg	< 1 pg	$\leq 10^{-7}$ KU/ $\mu$ L	$\leq 10^{-9}$ KU/ $\mu$ L	$\leq 0.001$ EU/mL	< 2 ng/sample	$\leq 500$ ng/mL	< $2 \times 10^{-12}$ mg/ $\mu$ L	None detected
<b>Brand – A</b>	–	–	"DNase Free"	"RNase Free"	$\leq 0.05$ EU	–	–	–	–
<b>Brand – B</b>	< 0.40 fg	–	–	< 8.6 fg	< 1 pg	–	–	< 1 fg	–
<b>Brand – C</b>	< 2 pg	< 50 fg	$10^{-4}$ KU	$10^{-9}$ KU	< 0.001 EU/mL	< 1 ng/ $\mu$ L	–	< $5.5 \times 10^{-12}$ mg	< 10 targets amplifiable
<b>Brand – D</b>	None detected	–	None detected	None detected	< 0.06 EU/mL	–	–	–	None detected
<b>Brand – E</b>	< 1 pg	–	"Free of"	"Free of"	< 0.05 EU/mL	–	"Free of"	ATP-free	–
<b>Brand – F</b>	"Free of"	"Free of"	"Free of"	"Free of"	"Free of"	–	"Free of"	"ATP-free"	"Free of"
<b>Brand – G</b>	–	–	< $6.25 \times 10^{-5}$ U/ $\mu$ L	< $3.125 \times 10^{-9}$ U/ $\mu$ L	< 0.03 EU/mL	–	–	–	–
<b>Brand – H</b>	< 30 pg	–	< $10 \times 10^{-7}$ KU/ $\mu$ L	< $10^{-9}$ KU/ $\mu$ L	< 0.06 EU/mL	–	–	–	–
<b>Brand – I</b>	< 30 pg	–	< $10^{-7}$ KU/ $\mu$ L	< $10^{-9}$ KU/ $\mu$ L	$\leq 0.06$ EU/mL	–	–	< $10^{-13}$ mg/ $\mu$ L	None detected
<b>Brand – J</b>	"Free of"	"Free of"	"Free of"	"Free of"	"Free of"	–	–	–	–

► [www.mt.com/BioCleanUltra](http://www.mt.com/BioCleanUltra)

### **Purity and inertness**

In addition to biological contaminants, other types of substances may be found on or within the tips that can contaminate samples and adversely affect data fidelity, including:

- Releasing agents
- Leachables
- Trace metals and trace organics
- PCR inhibitors

Releasing agents are generally lubricants or detergents added to plastic resins by the manufacturer to reduce cycle times and improve the ejection of molded parts from the molds. Other contaminants may be present within plastics as a result of the various chemical constituents used in polymer synthesis. High-quality tips are made of virgin polypropylene, certified to be free of additives, dyes or recycled materials.

### **Molding**

Molding defects can harm pipette tip performance and pipetting accuracy. Common tip molding defects found in lower quality products include:

- Flash is comprised of thin areas of residual plastic that form between ill-fitting mold components under pressure. In addition to mere cosmetic impact, flash can have a substantial negative impact upon pipetting accuracy if it occurs at the orifice end of the tip.
- Tip runout and other coaxial defects affect the straightness of the tip. Tip curvature becomes most problematic when several tips are used in parallel on a multichannel pipette, particularly when working with 96-well plates.
- Short shots result in incompletely formed tips, with most defects occurring at the tip ends. If present at the orifice end, this defect can adversely affect liquid movement into and out of the tip and have a dramatic effect upon pipetting accuracy.
- Surface roughness on the interior of the tip can impede the movement of liquid within the tip and lead to liquid retention during dispensing.

To prevent these molding defects and the resulting product and related performance issues, a high-quality manufacturing process will minimize the occurrence of tip defects by:

- Investing in fine-precision tip molds and equipment.
- Maintaining and routinely inspect molds.
- Continuously subjecting tips to quality testing in real time to eliminate opportunities for defects.

## Manufacturing and traceability

It is crucial that tip manufacturers perform stringent, verifiable quality testing for the presence of biological contamination and provide their test criteria to support all quality assertions. In addition, all equipment and assembly processes should be continually monitored in the clean room on a regular basis. By doing so manufacturers can monitor the fidelity of their production environment, ensuring that no systematic intrusions of contamination have occurred.

After molding, Rainin tips are packaged into various formats within a clean-room environment. Automation is employed to eliminate the need for human contact with tips, eliminating an opportunity for biological contamination. To assure full traceability, Rainin assigns a detailed nine-digit batch code to all of its products. This batch code is accompanied by other product-specific information on all tip product labels.

**RAININ**

**200 µL BioClean Ultra™**

**UNV**

Wide-O, LR, Filter

Sterilized

PN 30389188 Batch 1743, 31522 M3

**METTLER TOLEDO**

1743: 2017 + Week

31522: Day + Hour + Minute  
Day 3 (Tuesday)  
Hour 15 (3 PM)  
Minute 22

Machine Number

30389188: PN and Ordering Number

# Pipetting Techniques

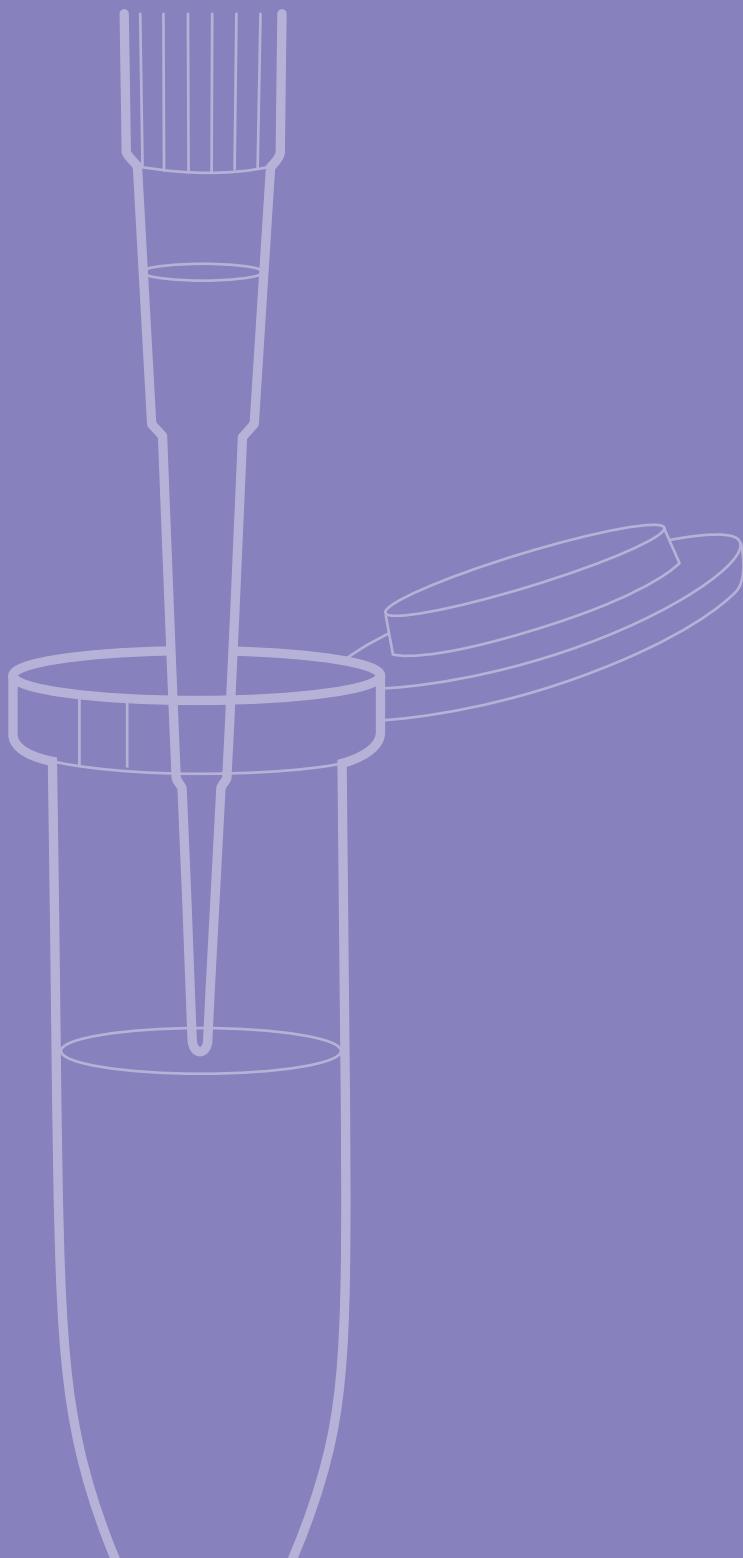



---

## Pipetting Techniques

Accuracy and reproducibility are essential to scientific research. Correct evaluation of applications and workflows – and therefore the selection of instruments and tips – significantly impact downstream results. However, there are other influences that contribute to the overall quality of results. For better, more reliable results, the following pipetting techniques should be implemented.

## Operating Range

### Optimal volume range

The normal operating range for most pipettes is 10 – 100% of nominal volume. Although this is considered to be the operating range, the performance specifications will change as the volume setting decreases.

The optimal volume range to deliver the most accurate volume is very dynamic. The pipette itself is only one of the contributing factors to pipetting uncertainty. In practice, pipetting skills and techniques may contribute even higher uncertainties to the delivered volume than the pipette. To account for uncertainties arising from the user, the liquid type, environmental variations and other uncontrollable factors, the known uncertainty may be multiplied by a safety factor. This safety factor provides an additional safety margin between the safe pipetting range and the instrument's limit (see Safe Pipetting Range, pages 68-71).

However, there are simple yet effective ways to ensure consistent volumes. Avoid setting the pipette's volume to less than 10% of its nominal volume. If possible, switch to a smaller pipette volume range for smaller volumes. Pipetting down to 10% can affect systematic error as much as 12% (for a 2  $\mu$ L pipette).

The systematic error specification for a Rainin Pipet-Lite XLS+ 100  $\mu$ L pipette is  $\pm 0.8\%$  for 50% and 100% of its nominal volume. Pipetting at 10  $\mu$ L (or 10% of nominal) can increase systematic error by more than 4 times greater, or 3.5%.

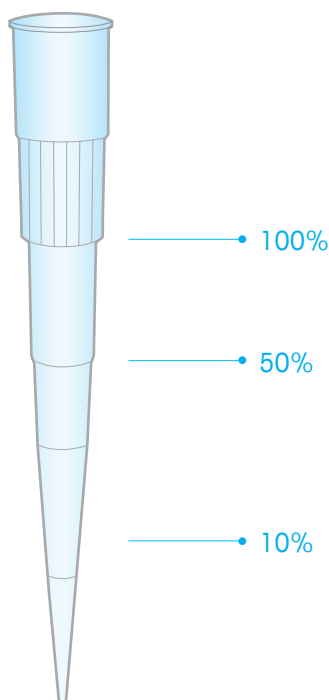

**Figure 12. Pipetting volume vs. range.** Rainin 200  $\mu$ L tip shown with 10%, 50% and 100% nominal volumes. Pipetting down to 10% can increase systematic error by as much as 2.5%.

## Tip Immersion

### Immersion depth

Correct tip immersion depth, particularly important for micro-volume pipettes, can improve accuracy by up to 5%. The tip should be immersed between 1-2 mm for micro-volume pipettes and up to 6-10 mm for large-volume 200-2000  $\mu\text{L}$  pipettes. If the tip is immersed too far, the volume of air in the tip is compressed, causing too much liquid to be aspirated. Liquid retained on the tip surface can also distort results. If the tip is not immersed far enough, air can be drawn in, resulting in air bubbles and inaccurate volumes.

Correct tip immersion depth can improve accuracy by up to 5%, so use the recommended depths as shown above (>2000  $\mu\text{L}$ , use 6 – 10 mm depth).

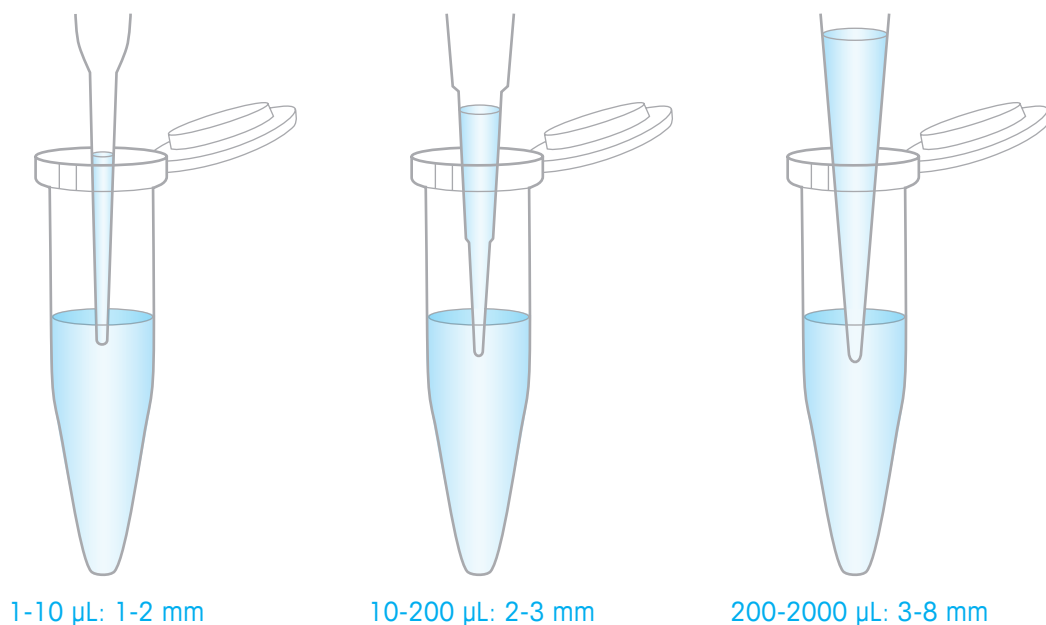

Figure 13. Tip immersion depths for 1 to 2000  $\mu\text{L}$  tips.

## Aspiration

### Maintain vertical angle

The angle of the pipette tip in the sample should be as close as possible to 90° when aspirating liquid samples and should not deviate more than 20° from vertical.

For micro-volume pipettes, keeping the angle as close to vertical as possible can improve accuracy by up to 2.5%.

Angles greater than 20° can produce inaccurate measurements – too much liquid will be drawn into the tip, resulting in inaccurate aspiration.

An immersion angle of 60° can cause aspiration of up to 0.7% more liquid than intended.

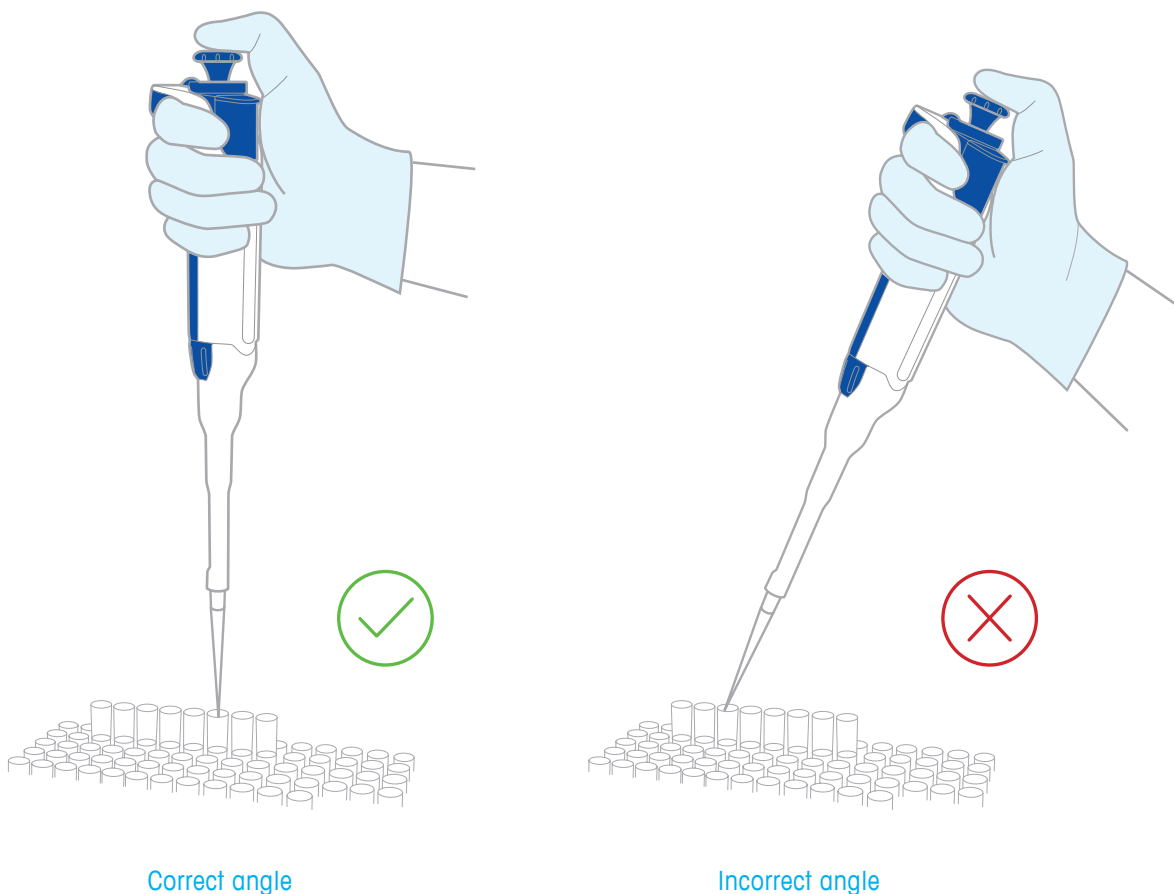

Figure 14. Correct vs. incorrect immersion angles.

## Maintain consistency

Maintaining a consistent pipetting rhythm and speed will help produce optimal, more repeatable results. Avoid hurrying and get into a rhythm for each step in the pipetting cycle to achieve an accuracy improvement of up to 5%.

## Smooth plunger action

Maintain consistent speed and smoothness when pressing and releasing the plunger. Uncontrolled aspiration can cause bubbles, splashing, aerosols and contamination of the pipette shaft and piston and can also lead to loss of sample.

### Large-volume pipettes

For larger volumes – typically 1 mL or greater – pause about 1 second or more after the sample pick up, with the tip still in the liquid. This will allow the sample to fully aspirate.

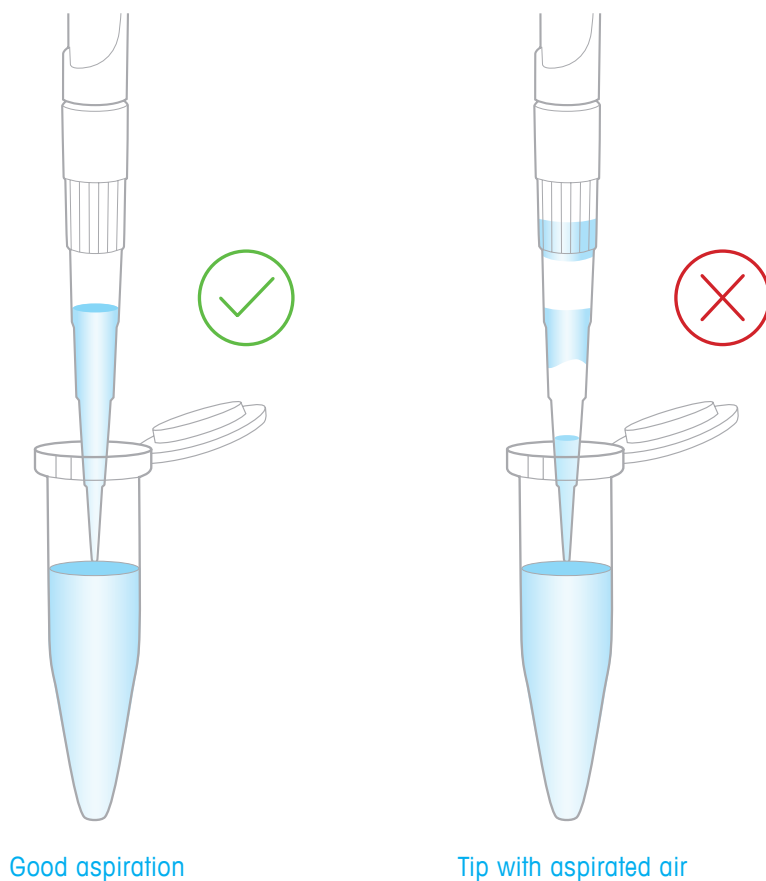

Figure 15. Aspiration using consistent pipetting rhythm avoids air gaps and bubbles.

## Dispensing

### Consistent sample dispensing

The greatest accuracy and sample-to-sample reproducibility are achieved by ensuring that every last drop of the sample is dispensed and does not adhere to the orifice. This is especially crucial when pipetting micro-volumes, due to the small sample volumes involved.

Good dispensing technique can improve accuracy by up to 1%. One of the most common techniques to dispense liquids is to touch the tip against the side of the wall of the vessel. When dispensing the sample, make sure the end touches the vessel wall, preventing the sample from remaining in the tip. After dispensing, slide the tip end up the vessel wall to release any liquid remaining on the orifice. This technique is limited to situations where cross-contamination is not critical. Other techniques that limit contact between tip and vessels samples include dispensing the sample into liquid or dispensing onto a liquid surface.

Dispense into the liquid or onto the liquid surface. When dispensing directly into or onto the liquid, press the plunger to the second stop to avoid picking up the sample after dispensing.

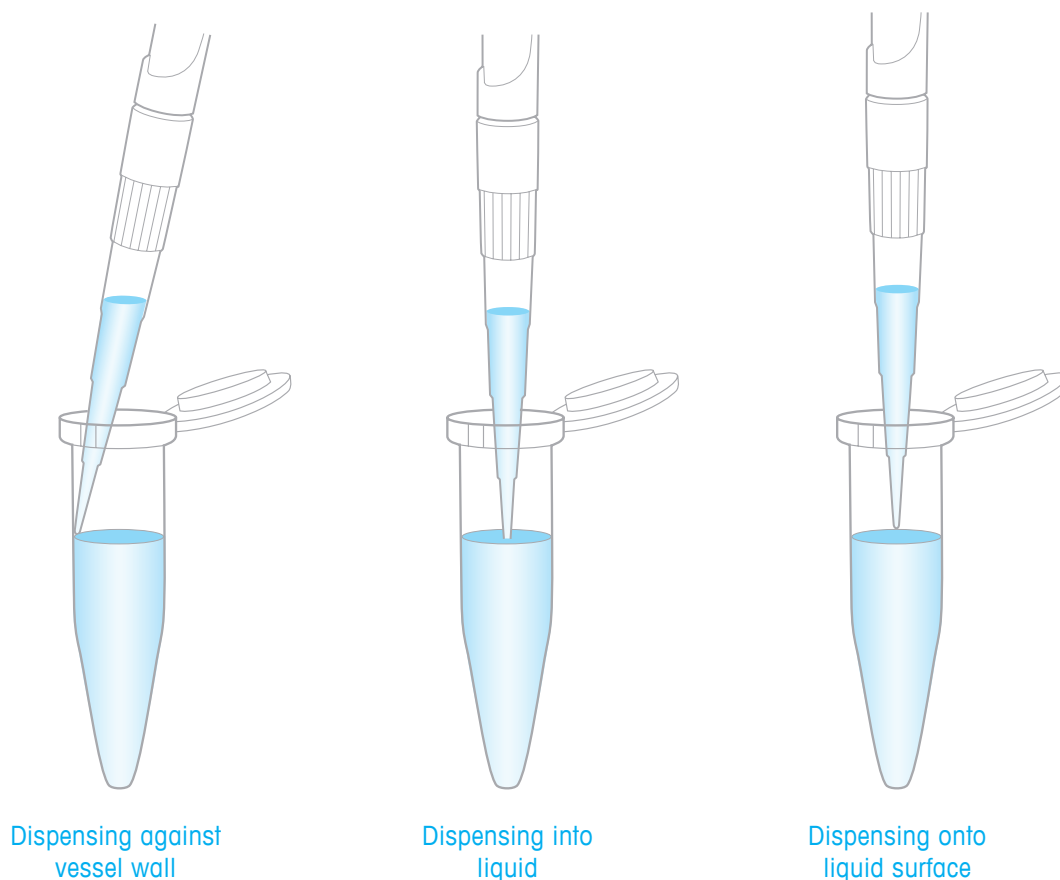

Figure 16. Consistent sample dispensing with good technique.

---

## Pre-rinsing

### Pre-rinse tips

Pre-rinsing the tip two or three times forms a liquid film inside the tip that can increase accuracy by up to 0.2%. Pre-rinsing helps neutralize capillary effects in micro-volume pipettes and, for large-volume tips, equalizes the air temperature inside the tip with the temperature of the sample.

### Exceptions to pre-rinsing

Pre-rinsing can adversely affect results when pipetting very warm and cold solutions, such as solutions stored at 4°C, when samples are kept on ice, or solutions above 37°C (water bath or heat blocks), as it may result in up to a 5% error.

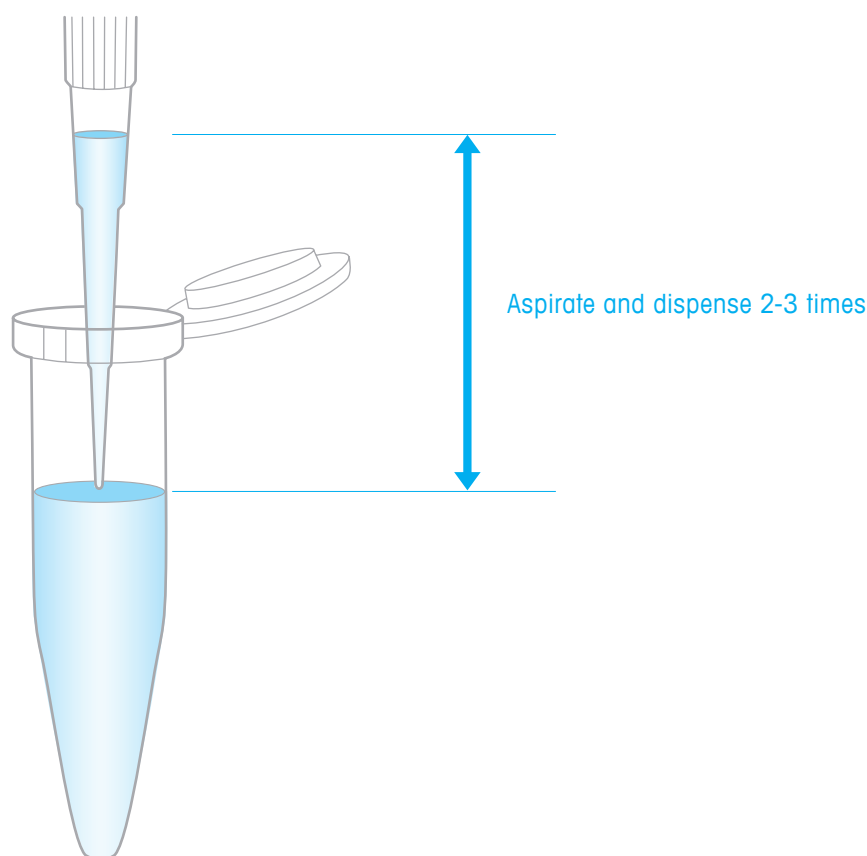

Figure 17. Pre-rinsing tips with the same liquid used.

### Environment

#### Maintain constant room temperature

An ideal temperature for pipetting is  $21.5^{\circ}\text{C} \pm 1^{\circ}\text{C}$ , the same as used for calibration. Avoid drafty or sunlit areas with large or sudden temperature changes that could compromise aspiration accuracy. Pipetting at a constant temperature can improve results by as much as 5%.

#### Allow time for equilibration

Another important aspect of temperature variation is the equilibration time. Pipetting accuracy is affected by temperature variation of hot or cold samples: cold liquids tend to deliver in excess, while warm liquids may deliver smaller volumes than expected. Unless otherwise specified, allow sufficient time for the pipettes and liquids to reach equilibrium temperature.

#### Avoid hand-warming effects

Over long periods of pipetting, heat from the hand can warm the pipette, causing the air space inside to expand and produce inaccurate results. Avoid the effects of hand-warming by using high-quality pipettes made from PVDF polymers. In addition, between pipetting cycles, replace the pipette on its stand instead of holding it in hand.



Rainin SmartStand,  
Universal Carousel Stand  
and Hang-Ups offer  
pipette storage and avoids  
hand-warming effects.

► [www.mt.com/pipette-accessories](http://www.mt.com/pipette-accessories)

► [www.mt.com/SmartStand](http://www.mt.com/SmartStand)



## Adjusting Volumes

### Consistent micrometer settings

When changing the volume from a higher to a lower setting, dial down to the desired volume setting. However, when changing the volume from a lower to a higher setting, first turn the selector wheel about 1/3 turn above the desired volume setting, then slowly down to the setting. This avoids mechanical backlash and results in greater accuracy.

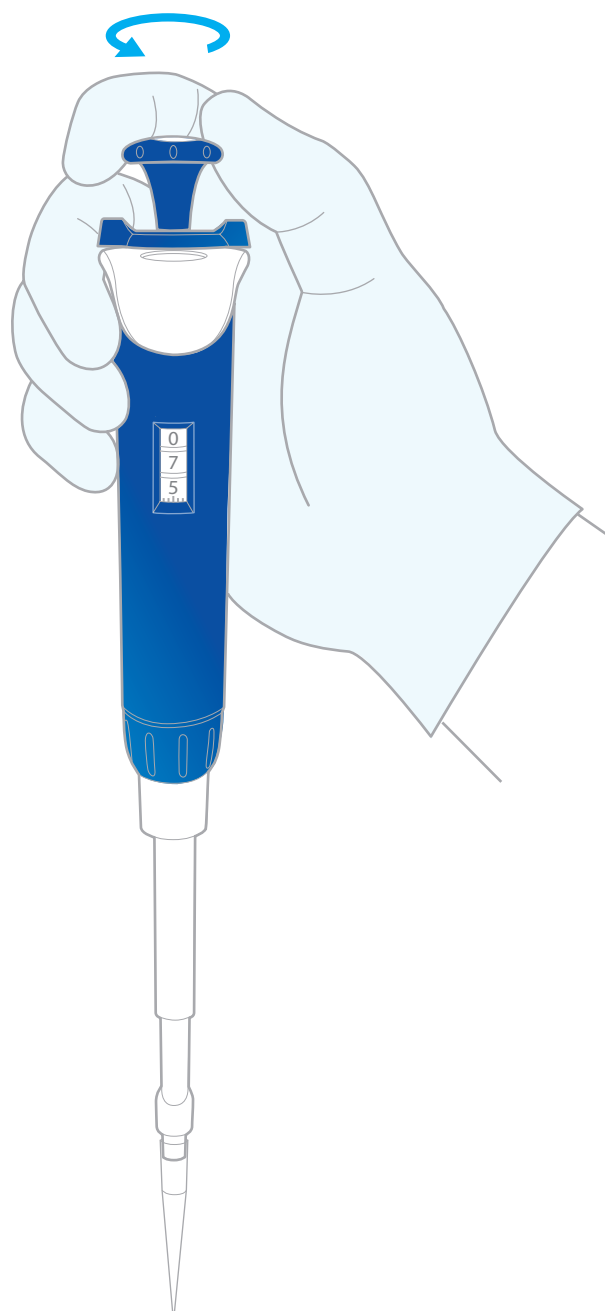

Technique Error	Accuracy Impact (%)
Micrometer	0.5%
Optimizing volume range	Varies
Tip immersion angle	2.5%
Tip immersion depth	1%
Tip immersion time	Varies
Aspiration rate	1-5%
Dispensing techniques	1%
Pre-rinsing	0.2%
Hand-warming	0.5%
Pipetting technique vs. sample type	Varies

**Table 4. Pipetting technique errors and their accuracy impact that should be avoided whenever possible.**

### Routine Cleaning

#### Clean the pipette

Basic exterior cleaning and full decontamination will help ensure pipettes are contaminant-free. There are three types of contamination that can occur from pipetting:

#### Pipette-to-sample

The sample is contaminated by a contaminated pipette or pipette tip.

#### Sample-to-pipette

The pipette body is contaminated by the sample or aerosol particles.

#### Sample-to-sample

The sample is contaminated by the previous sample due to residual carry over.

The method for pipette decontamination depends on the sample type used, however if done improperly, it can adversely affect the pipette's performance. Take extra caution when following recommended decontamination protocols. When using cleansers, particularly bleach, be sure to rinse thoroughly.

#### Basic exterior cleaning

- Wipe exterior using a non-abrasive cloth moistened with fresh 10% bleach solution, or 60% isopropyl alcohol, or detergent solution.
- Lightly scrub any caked-on grit with a toothbrush.
- Use any detergent designed to clean labware. If sold as concentrate, dilute to manufacturer's recommended strength.
- Use care around the volume display window – excess liquid can fog or stain the screen, requiring service to replace.
- With water or distilled water, wet a non-abrasive cloth and wipe off the pipette.

#### To prevent cross-contamination

---

- Clean pipettes regularly
- Maintain smooth plunger action
- Change pipette tips after each sample
- Use filter tips

Reduce common pipetting errors and improve reproducibility with Rainin Good Pipetting Practice technique posters:

#### Get Better Results

Consult these techniques to achieve better results consistently.

#### Pipette Challenging Liquids

Overcome difficulties in pipetting challenging liquids.

#### Cleaning a Pipette

Learn how to decontaminate and keep pipettes clean.

► [www.mt.com/raininposters](http://www.mt.com/raininposters)

## Full decontamination (single channel pipettes only)

The recommended cleaning agents and guidelines are suited for Rainin tip ejectors and shafts. Always follow the decontamination protocols recommended by the pipette manufacturer.



Tip ejector

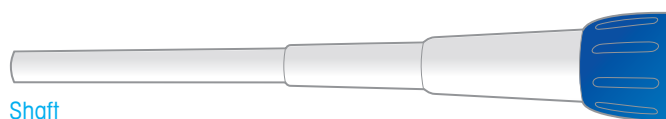

Shaft

Sample	Recommended Cleaning Agent	Cleaning Guideline (Rainin Tip Ejector and Shaft Only)
<b>DNA, RNA</b>	Fresh 10% bleach solution or DNA/RNA cleanser	Immerse for 10 minutes. Rinse with distilled water. Wipe with isopropyl alcohol and allow to air dry.
<b>Proteins</b>	Fresh 10% bleach solution or detergent. Not alcohol	Immerse for 10 minutes. Rinse with distilled water and allow to air dry.
<b>RNase</b>	RNase decontaminant solution (RNaseAway®, RNaseZap®) or 95% EtOH followed by 3% H <sub>2</sub> O <sub>2</sub>	Immerse in RNase decontaminant solution for one minute, then rinse with distilled water and air dry. Alternatively, immerse briefly in 95% ethanol, rinse, then immerse in 3% hydrogen peroxide for 10 minutes. Rinse, and air dry.
<b>Aqueous Solutions</b>	Detergent solution or 70% ethanol	Immerse for 5 minutes. Rinse with distilled water, then wipe with isopropyl alcohol and allow to air dry.
<b>Organic Solvents</b>	Detergent solution	Immerse for 5 minutes. Rinse with distilled water and allow to air dry.
<b>Radioactive Samples</b>	High-strength radioactivity decontaminant (COUNT-OFF™ surface cleaner, Decon 90™ cleaning agent)	Immerse for 5 minutes. Rinse 3x with distilled water. Measure with Geiger counter for radioactivity. Properly dispose of gloves, liquids and all cleaning materials according to your organization's radioactive safety procedures.

**Notes:** Rainin shafts and tip ejectors are fully autoclavable. On XLS+ models, the piston assembly is also autoclavable. When using cleansers – particularly bleach – be sure to rinse thoroughly.

RNase AWAY and RNaseZap are trademarks of Thermo Fisher Scientific. COUNT-OFF is a trademark of PerkinElmer Inc. Decon 90 is a trademark of Decon Laboratories Limited.

### **Ergonomic Pipetting**

Because many laboratory tasks are repetitive, good ergonomic practices are especially important. All too often, repetitive tasks are performed by researchers in awkward postures and less-than-ideal positions. The application of ergonomic principles and low-cost changes to equipment can reduce repetitive strain injuries (RSIs) and the costs associated.

#### **Plan ahead**

Determine the amount of pipetting required during lab work and if possible, limit the amount of pipetting to 20 minutes at a stretch. This will help reduce the amount of hours spent pipetting at the lab bench without breaks. Ideally, alternate pipetting with other tasks or take frequent, short breaks to stretch.

#### **Stretch**

Stretching is an easy way to prevent strain while pipetting and maintain comfort in the lab. It is good practice to get up from the lab bench every 20 or 30 minutes, and implementing a simple stretching routine can significantly reduce the stiffness and stress that accumulate throughout the day.

#### **Maintain good bench posture**

Practicing good bench posture while pipetting can significantly reduce the risk of pain or injury that accumulates after spending extended periods of time in the lab. To avoid overreaching and awkward positions at the lab bench, maintain good upright body posture while sitting or standing and adjust forearms to be parallel and aligned with pipetting wrist.

## Choose an ergonomic pipette

Ergonomic pipettes are proven to reduce the risk of RSIs and increase pipetting accuracy. Avoid fatigue-related strain and pipetting errors by adopting an ergonomic pipetting system that minimizes pipetting forces on the thumb and wrists. Look for pipettes with:

- Low plunger forces
- Low tip ejection forces
- Hand comfort and fit (without gripping tightly)
- Lightweight materials
- Good tip selection – mismatched pipettes and tips usually require more force to load/eject and may not seal properly
- Add multichannel, electronic pipettes or repeaters for repetitious work and consider semi-automated liquid handling systems for high-throughput work

Rainin LTS™ LifeTouch System dramatically reduces the amount of force required to load and eject tips. See pages 62-63 for more details.

## Do not ignore symptoms

Weakness or pain in the pipetting thumb or wrist can indicate early symptoms of RSIs and should not be ignored. When experiencing continuous pain or discomfort during extended periods of pipetting, take a break from pipetting for a few days or stop completely and consult a physician or local occupational health clinic to prevent additional injury.

Improve pipetting ergonomics and prevent injury with these quick reference posters from Rainin:

### Stretch!

"Hands, Arms and Shoulders" stretching routine to improve ergonomics in the lab.

### Bench Posture – It Matters!

Proper sitting, standing and pipetting postures to prevent strain on the body during prolonged hours at the bench.

### Thumbs Up!

Stretching exercises to strengthen the pipetting thumb and prevent injury.

► [www.mt.com/raininposters](http://www.mt.com/raininposters)

### The Rainin LTS™ LiteTouch™ difference

Recognizing that the ergonomic issues associated with tip loading and ejection have a significant impact upon manual fatigue, pipetting accuracy and repetitive stress injuries, Rainin developed a revolutionary pipette and tip design called LTS or the LiteTouch System. LTS dramatically reduces the forces associated with tip loading and ejection.

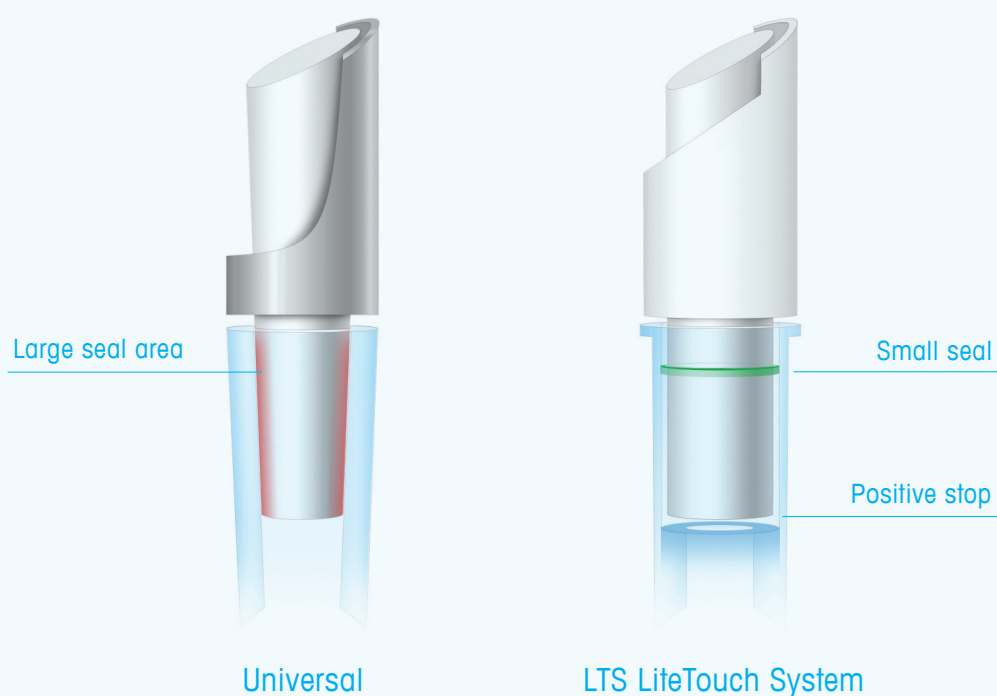

► [www.mt.com/LTS](http://www.mt.com/LTS)

These LTS design features work together to reduce tip loading and ejection forces and improve pipetting ergonomics by reducing manual fatigue:

- The **cylindrical shape** of the LTS tip sealing end eliminates the need to force the pipette into the tip. This reduces the amount of force required to seat the tip and hence, the amount of force required to eventually eject the tip.
- The **sealing ring** establishes an airtight seal between the LTS tip and pipette, without the need for a large amount of surface area contact between the tip and the pipette, and associated frictional interaction. This substantially reduces the amount of force required to eject the tip.
- The **positive stop** prevents the shaft from being forced deeper into the tip, beyond the depth of insertion required to establish an airtight seal. This creates sealing uniformity among tips and reduces the amount of force required to eject the tip.
- The design of the sealing area provides excellent lateral stability, which prevents the tip from shifting during use, maintaining seal integrity and pipetting accuracy.





---

## Pipetting Accuracy

Pipetting accuracy is a measure of the ability of the user working with a pipette to provide a dispensed amount of liquid at or near the volume indicated on the volume setting. In general, five factors affect pipetting accuracy:

- Uncertainty of the pipette instrument
- The type of liquid (physical and/or chemical properties)
- Pipette tips
- User technique
- Environmental influences, such as temperature and air pressure

### **Uncertainty of the Pipette**

When considering the performance of calibrated pipettes, detectable variations from the set volume are attributable to both systematic error and random error.

Systematic error is a measure of trueness of the pipetting operation and shows the user how close to the target volume (set volume) they are. Calibration mitigates this error type and reduces any bias that may occur during pipetting. The individual user can have a significant impact on systematic error. It is common for individuals to have different methods of handling a pipette, which can lead to over- or under-pipetting, depending on their technique, in a manner that is independent of pipette calibration.

Random error – the measure of precision of the pipetting operation – is a combination of many errors including pipetting technique (potentially, the most dominant issue). This type of error is also impacted by the quality of the pipette design and build, its age and condition, the environment it is used in, etc.

---

## Systematic error, random error and uncertainty

Typical **systematic error** specifications for air displacement pipettes are approximately 1% for pipettes with nominal volume settings greater than 35%. For pipette volume settings at 10% or below, the specifications can be up to 3 times less accurate. In other words, expect accuracy to decrease when pipetting smaller volumes of liquid.

**Random error** measures the ability of the pipette to provide reproducibly similar dispenses of a specific liquid volume. It is often referred to as repeatability or sample reproducibility, and is quantified as a standard deviation and described as precision. The lower the standard deviation, the better the reproducibility, and hence, the precision.

**Uncertainty (or accuracy)** accounts for both systematic and random error. Any volumetric measurement should be corrected for its systematic error. In principle, for pipetting this would mean that the systematic error needs to be subtracted from every delivered volume. However in practice, this is not practical. Instead, the "uncertainty in use of a single delivered volume" is calculated using the following equation:

Uncertainty [ $\mu\text{L}$ ] = | Systematic Error | + k x Random Error

Where k is the expansion factor and equals 2 for ten repeated measurements.

### Safe Pipetting Range

The need for speed and accuracy in lab work must be balanced as different large-volume tools have different capabilities. Historically, the recommended guideline for choosing the correct-volume pipette was to estimate the working range as between 35% and 100% of the total volume indicated. For example, using that empirical rule, a 1,000  $\mu\text{L}$  pipette has an effective working range of between 350 and 1,000  $\mu\text{L}$ . Even though the minimum specifications may be 100  $\mu\text{L}$  on this volume pipette and the instrument is adjustable down to 0  $\mu\text{L}$ , the recommendation for using 350  $\mu\text{L}$  as the minimum is based upon user technique. Using this rule, more precise pipetting technique is required for volumes below the 35% range on pipettes. Working at an inappropriate range of any instrument will compromise accuracy.

However, the “35% rule” for selecting the correct-volume pipette has its own limitations:

- The rule is based on empirical knowledge: There is not solid scientific evidence the safe working range is always between 35% and 100% nominal volume.
- It assumes that all air displacement pipettes behave the same, and that factors such as volume and type of sample may not affect delivered volume. For example, research has shown that a sample’s physical and chemical characteristics (viscosity), and the type of instrument used, may compromise the delivery of volume using specific air displacement pipettes.
- The rule is an estimation and assumes an absolute safe pipetting range. In reality, scientific evidence has demonstrated the range is dynamic and the estimation is not always intuitive or easy to calculate.

Data has shown a pipette's usable volume range depends on the maximum uncertainty of delivered volumes that is still acceptable to the user (see Figure 18). Generally, with variable volume pipettes the absolute uncertainty in use of delivered volumes increases with increasing volumes. The relative uncertainty in percentage, however, increases with decreasing volumes. The point where relative uncertainty and pipetting tolerance intersect defines the pipette instrument limit, which is also called minimum volume. When pipettes are used to deliver volumes below this limit, their uncertainty is larger than the acceptable tolerance, resulting in potentially inaccurate volumes (see Figure 18, red area). When pipettes are used in the safe pipetting range, however, the uncertainties are smaller than the set tolerance, yielding consistently accurate volumes.

The pipette itself is only one of the contributors in pipetting uncertainty. In practice, the user's pipetting skills and techniques may contribute even higher uncertainties to the delivered volume than the pipette. To account for uncertainties arising from the user, the liquid type, environmental variations and other uncontrollable factors, the known uncertainty may be multiplied by a safety factor. This safety factor provides an additional safety margin (see Figure 18, yellow area) between the safe pipetting range and the instrument's limit.

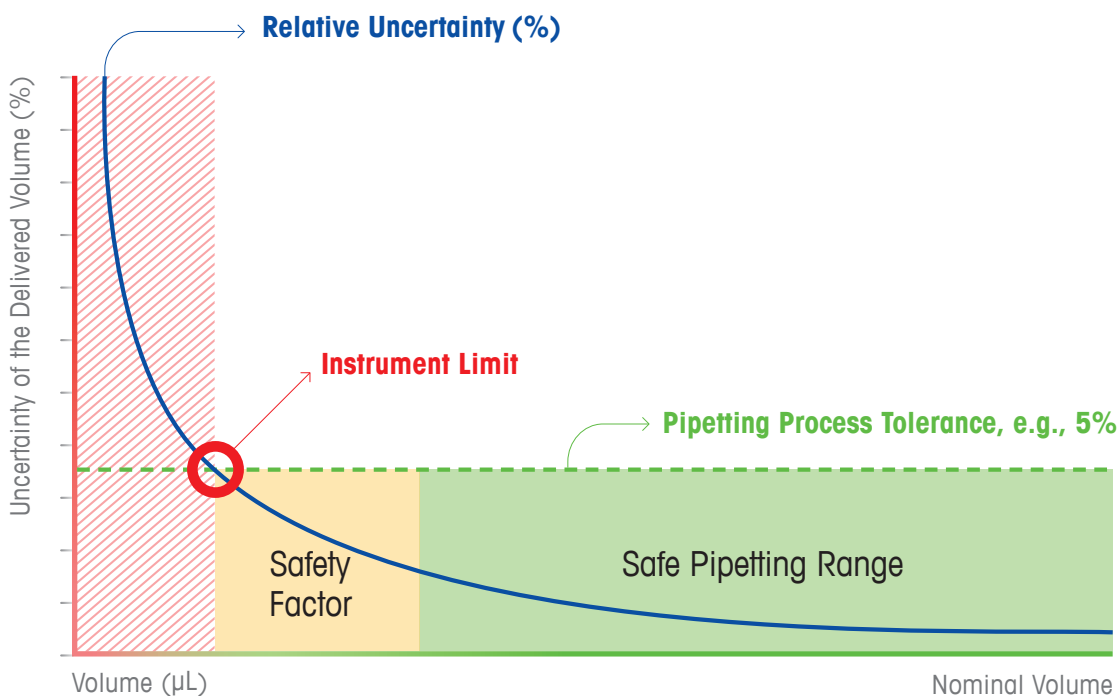

Figure 18. Safe pipetting range.

## Safe pipetting range terms of measurement

### Accuracy

Closeness of agreement between delivered volume and the nominal or selected volume. Accuracy is a combination of trueness and precision and can be assessed with both systematic and random error.

### Trueness

Closeness of agreement between the mean delivered volume and the selected volume.

### Precision

Closeness of agreement between replicate delivered volumes obtained under identical conditions.

### Systematic error

Difference between the mean volume and the nominal volume or selected volume of the pipette.

### Random error

Variation of the delivered volumes around the mean of the delivered volumes.

### Uncertainty

Parameter associated with the delivered volume that characterizes the dispersion of the volumes that could reasonably be attributed to the delivered volume.

Pipette Type	Rainin Pipette Model	Minimum Nominal Range	Maximum Nominal Range	Systematic Error (10%)	Random Error (10%)	Systematic Error (50%)	Random Error (50%)	Systematic Error (100%)	Random Error (100%)
Air Displacement	L-10XLS+	1 µL	10 µL	2.50 %	1.20 %	1.50 %	0.60 %	1.00 %	0.40 %
	L-200XLS+	20 µL	200 µL	2.50 %	1.00 %	0.80 %	0.25 %	0.80 %	0.15 %
	L-1000XLS+	100 µL	1000 µL	3.00 %	0.60 %	0.80 %	0.20 %	0.80 %	0.15 %
Positive Displacement	MR-25	5 µL	50 µL	8.30 %	2.60 %	2.70 %	0.80 %	1.20 %	0.40 %
	MR-250	25 µL	250 µL	3.00 %	0.60 %	1.70 %	0.30 %	1.00 %	0.20 %
	MR-1000	100 µL	1000 µL	3.00 %	1.60 %	1.00 %	0.50 %	0.80 %	0.40 %

Figure 18. Systematic and random errors for Rainin air displacement and positive displacement pipettes.

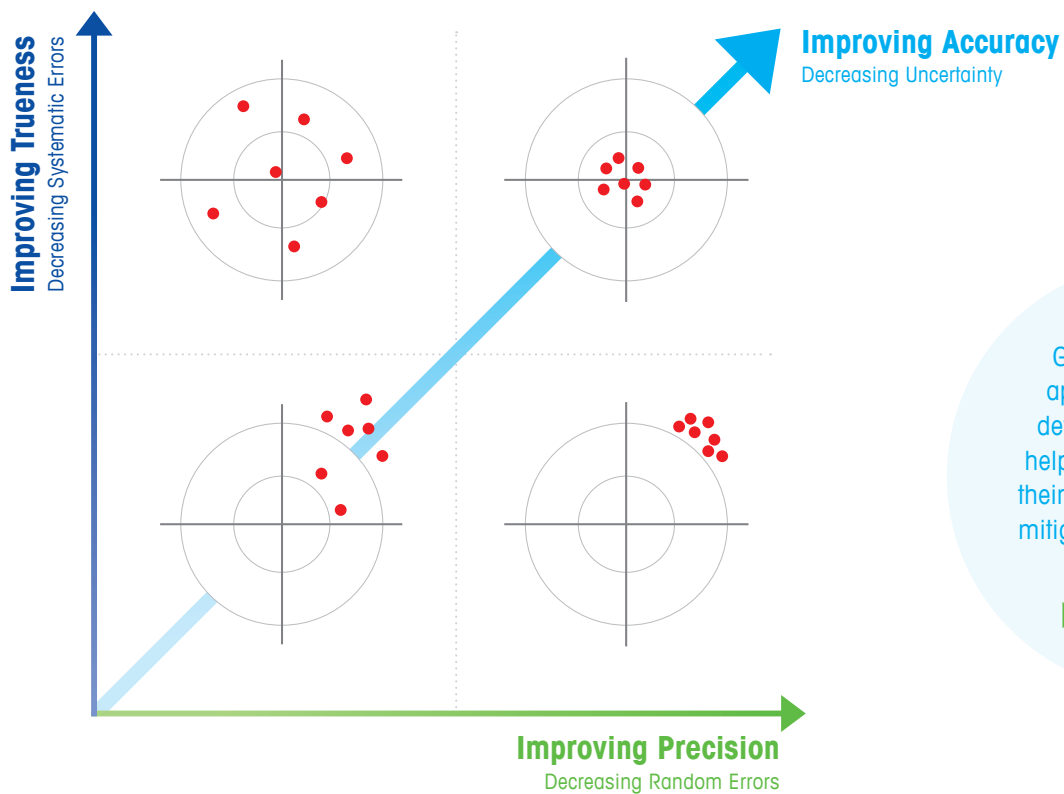

GPP is a systematic approach to pipetting developed by Rainin to help researchers improve their pipetting accuracy by mitigating both systematic and random error.

► [www.mt.com/gpp](http://www.mt.com/gpp)

**Accuracy = Trueness + Precision**  
**Uncertainty = Systematic Error + Random Error**

Type of Errors	Quantitative	Quantitative
<b>Systematic (SE)</b>	Trueness	Bias
<b>Random (RE)</b>	Precision	Standard deviation
<b>Total Errors (TE)</b>	Accuracy	Measurement of uncertainty

Figure 19. Graph shows accuracy as a function of trueness and precision.





---

## **Preventive Maintenance, Calibration and Verification**

In addition to good pipetting techniques, researchers can maximize pipetting performance and reduce measurement irreproducibility with routine pipette maintenance and calibration. Pipette performance is a function of many factors, including proper maintenance and periodic verifications to check if the desired performance and specifications are met. The importance of maintaining calibrated pipettes is so that, at a minimum, the mechanical variability of the pipette is minimized as a result of routine professional maintenance and calibration. This process can be enhanced by regular verification that the pipette in use meets the published specifications, a check that can be performed by using a high-performance balance.

## Preventive Maintenance and Calibration

Variations in pipette performance can introduce a hidden source of error to sample preparation and testing procedures, making regular maintenance and calibration crucial to the quality and reproducibility of results.

Pipettes should be calibrated every 12 months at a minimum; however, depending on the type of application and usage, pipettes may require more frequent calibration (every 3 to 6 months). Individual labs and researchers should evaluate their need for routine calibration based on the sensitivity of their experiments to pipetting errors and to the risks they would assume if their data were compromised. It is worth noting that highly trained and experienced service providers are capable of performing truly accurate independent checks of individual pipettes for both basic and regulated needs.

METTLER TOLEDO offers ISO accredited onsite or mail-in service to meet a wide range of pipette preventive maintenance and calibration needs.

### Pipette calibration services as performed by service providers

#### **As Found Data**

Document the status of the pipette prior to calibration.

#### **Cleaning and Maintenance**

Clean the pipette and replace critical mechanical parts.

#### **Calibration and Adjustment**

Calibrate the pipette with gravimetric testing.

#### **As Returned Calibration**

Document the status of the pipette after calibration and adjustment.

#### **Calibration Certificate**

Issue a calibration certificate as proof that the pipette has been tested and adjusted.

► [www.mt.com/pipette-service](http://www.mt.com/pipette-service)

## Pipette Verification

Professional calibration and service performed on a regular basis ensures optimal pipette performance to manufacturer's specifications. To ensure accurate pipetting, routine performance checks are an important complement to service visits to achieve a comprehensive performance verification strategy. Routine checks are critical for protocols that involve complex steps, and offer an added measure of security when pipetting reproducibility and accuracy are at risk (e.g., use of corrosive liquids, physical damage, untrained personnel). A simple routine check quickly confirms the pipette is still fit for its intended use and drastically reduces the risk of out-of-tolerance results.

Rainin SmartCheck is the first instrument dedicated to evaluating pipette verification. It still uses a gravimetric method, but simplifies and expedites the process to confirm whether a pipette is still working under defined tolerances.



► [www.mt.com/SmartCheck](http://www.mt.com/SmartCheck)

## Preventive Maintenance, Calibration and Verification

Routine performance checks – often called pipette quick checks or pipette verifications – are not the same as calibrations, but play an important role in maintaining optimal pipette performance. Traditionally, pipette verification involves a multi-step procedure in the laboratory requiring an analytical balance and deionized water. Users pipette the nominal pipette volume of deionized water onto a vessel and manually record the mass. This process is repeated a several times and the subsequent data is analyzed to estimate the pipette’s current systematic error and random error (average and standard deviation, respectively) to validate pipette performance.

	Analytical Balance	Rainin SmartCheck
Device Purpose	Any weighing task	Pipette verification only
Pipette Brand	Any manufacturer	Any manufacturer
Principle	Uncertainty (gravimetric)	Uncertainty (gravimetric)
Volume Range (µL)	0.2 – 1000*	7 predefined (10 – 1000)
Test Replicates	3 – 10	4
Test Evaluation (for a specific volume)	Systematic and random errors; uncertainty	Uncertainty
Test Speed	Varies	60 seconds for 4 measurements
Portable	No	Yes
Results	Quantitative (e.g., 7%)	Qualitative (pass/fail) Quantitative (with PipetteX)
Time to Set up (min)	~ 20	~ 2
Tare/Zero' It	Yes, every time	No, automatic
Requires Other Consumables	Yes	No
Requires Computer	Yes	Optional (with PipetteX)
Sample	Any*	Deionized water
Tolerance	Varies	Factory default: 5% Adjustable: 3 – 10% with PipetteX

---

## Pipette Management

Proper pipette performance is crucial to compliant, accurate data, but can be difficult to track systematically across large organizations. Managing pipette inventory is a manual process; creating asset lists, tracking down individual pipettes for maintenance and calibration, and logging calibration data can be time consuming and prone to errors.

Laboratories that have 100, 1000, or more pipettes benefit from using an automated pipette management system to simplify inventory tracking, service scheduling and storage of calibration data for every pipette. Automating pipette management offers a powerful solution for laboratories to monitor and maintain pipette performance, keeping assets organized, certified and audit ready across multiple labs or sites.



PipetteX pipette management software along with the SmartCheck verification device, provides a powerful solution for pipette tracking, calibration and risk management.

► [www.mt.com/PipetteX](http://www.mt.com/PipetteX)

# Benefit From Our Liquid Handling Expertise

With decades of experience in liquid handling, METTLER TOLEDO Rainin offers a wide range of online and on-site resources. Take advantage of our expertise to enhance your pipetting know-how and maximize your pipetting performance.



## Good Pipetting Practice

One-stop portal for resources to improve data quality through our comprehensive approach to maximizing pipetting accuracy and reproducibility. Find white papers, guides, videos, webinars and more.

► [www.mt.com/gpp](http://www.mt.com/gpp)



## Pipetting Technique Posters

Rainin technique posters display useful pipetting insights right in your lab, where quick reference by your research team can lead to better ergonomics and higher data fidelity.

► [www.mt.com/rainin-posters](http://www.mt.com/rainin-posters)



## Expert Pipette Service

METTLER TOLEDO's global network of factory trained technicians and ISO/IEC accredited pipette calibration labs ensures your instruments are restored to the highest accuracy and precision.

► [www.mt.com/pipette-service](http://www.mt.com/pipette-service)

[www.mt.com/rainin](http://www.mt.com/rainin)

For more information

## METTLER TOLEDO Group

Laboratory Division

Local contact: [www.mt.com/contacts](http://www.mt.com/contacts)

Subject to technical changes

© 11/2020 METTLER TOLEDO. All rights reserved.

17701066 Rev A