

toobsamsungkik

www.anadidununkadingucU.com

HA
05.17-
ackler
selvter.

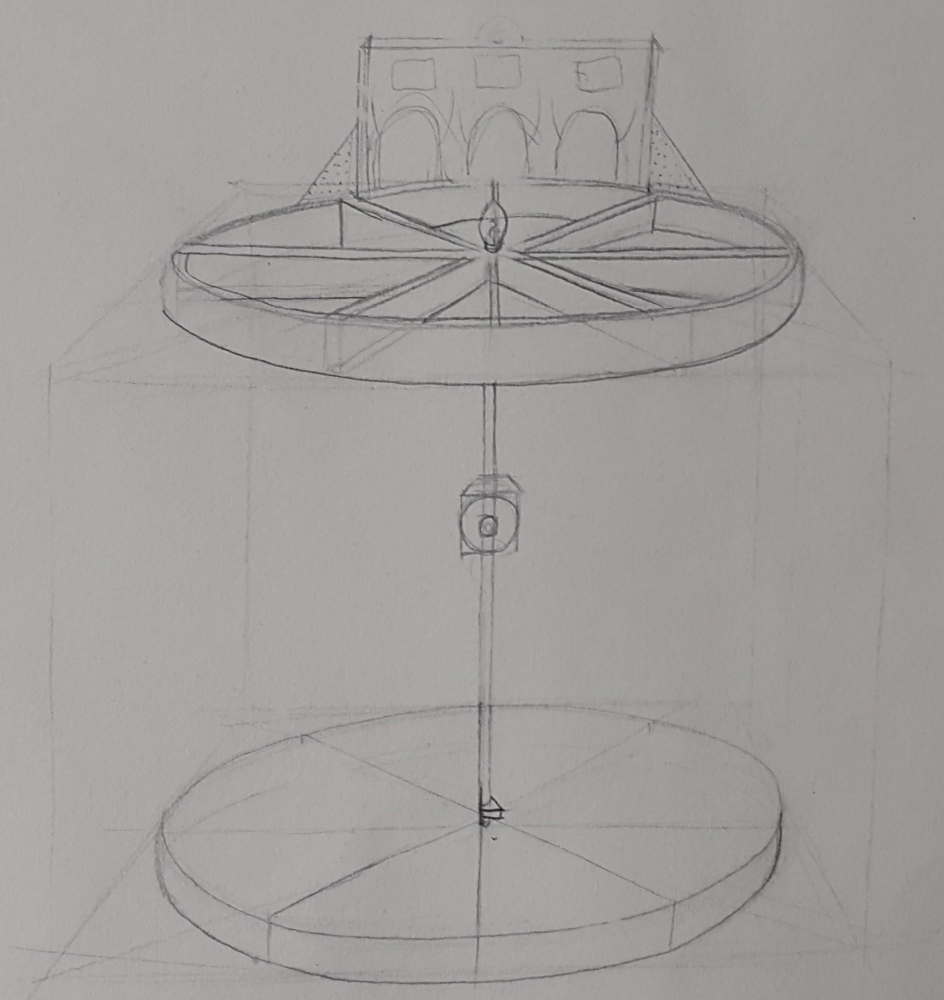

↓ ↗
03.12 -

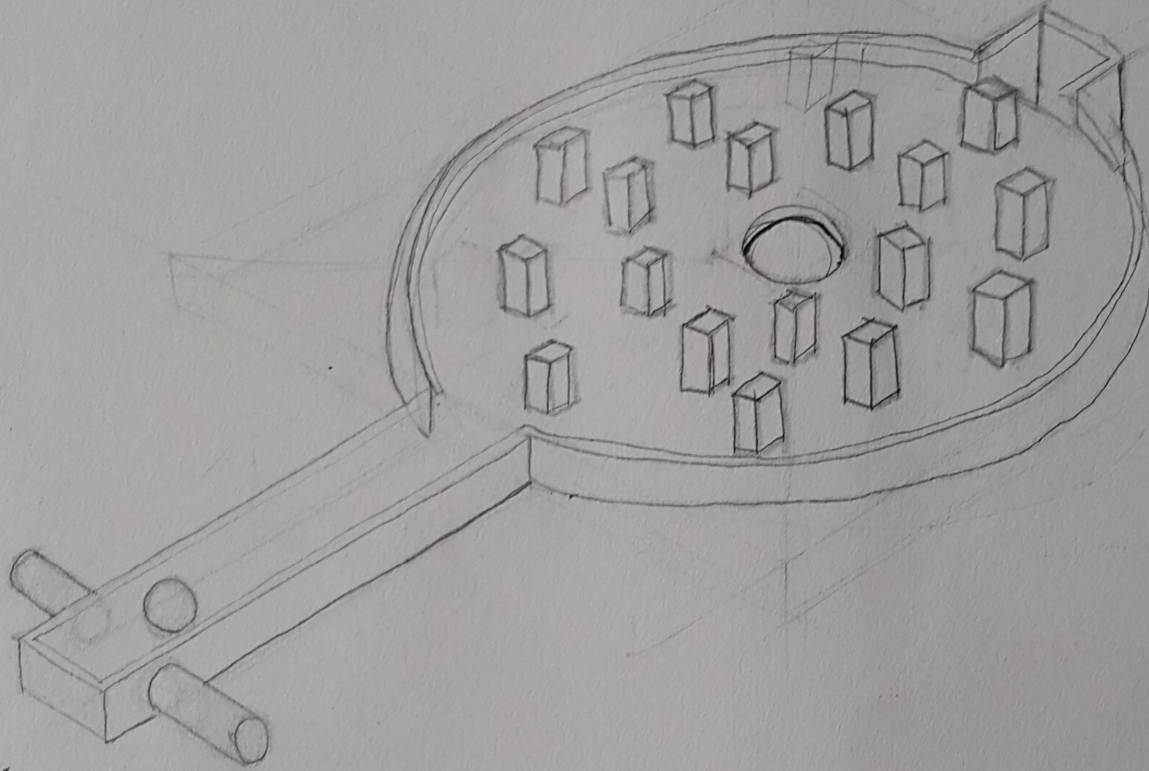

Denge Topu

Top, oynayan kişi tarafından en kısa sürede bloklardan geçer ve ortadaki boşluğa düşmesine izin verilmez. Eğer ki düştü oynayan kişi oyunu kaybeder. Burada önemli olan süre ve topun tutulacak yeri den tutulur ve elimiz ile topun dengesi sağlanır ve kutuyu düşürür.

1A

19.12

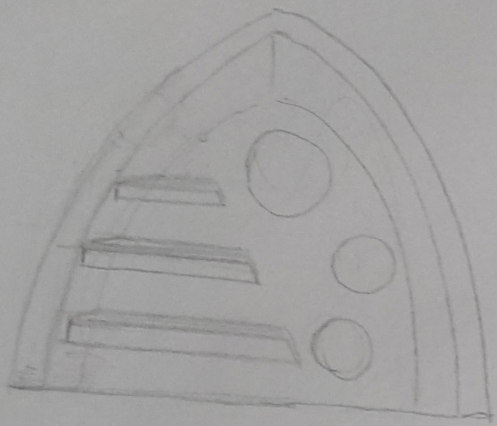

71

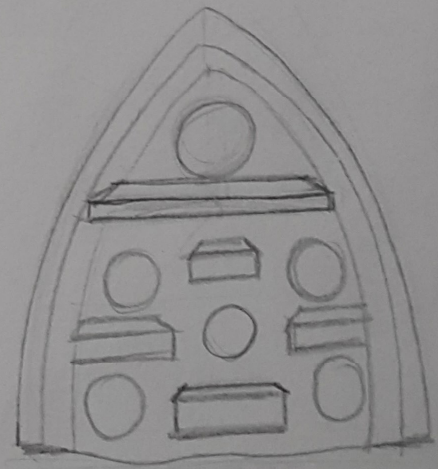
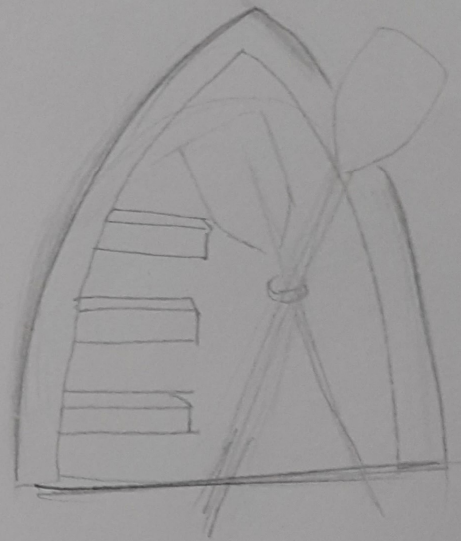

SA
19.12

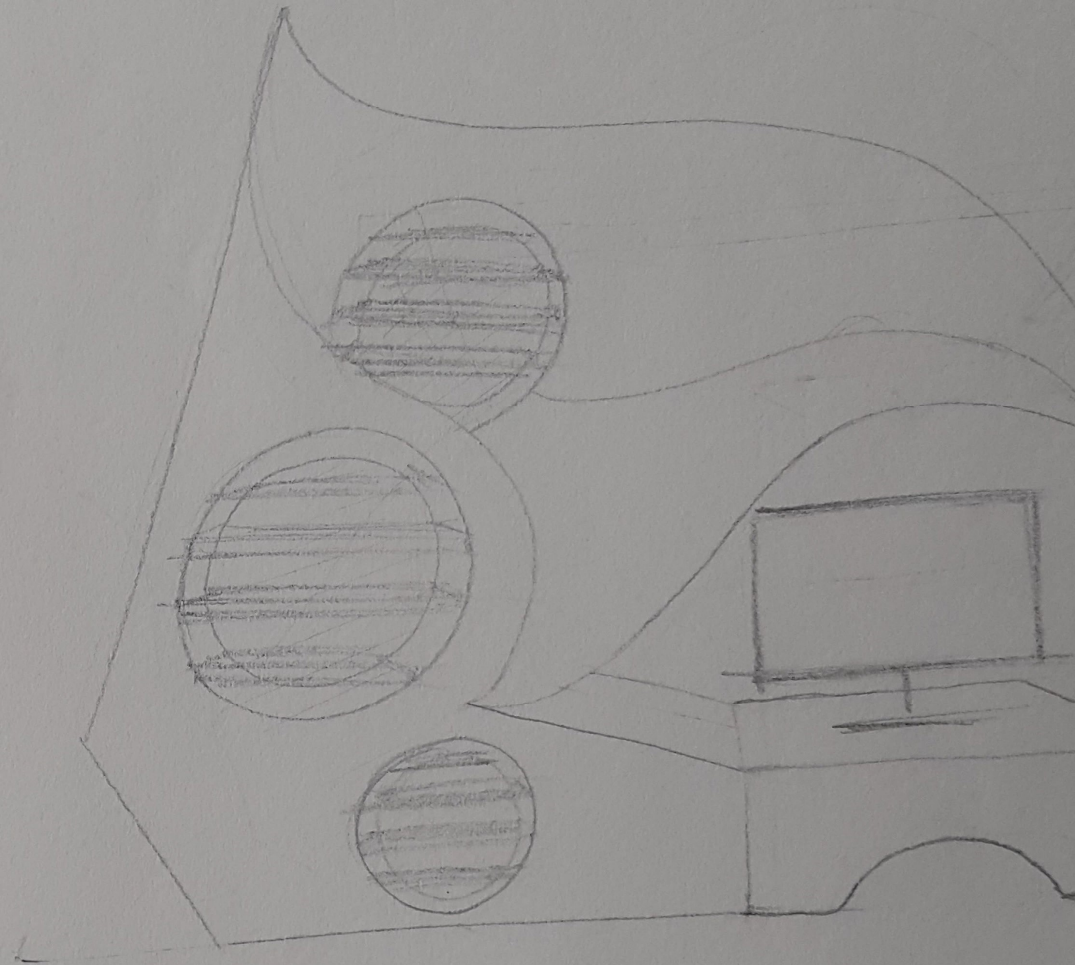
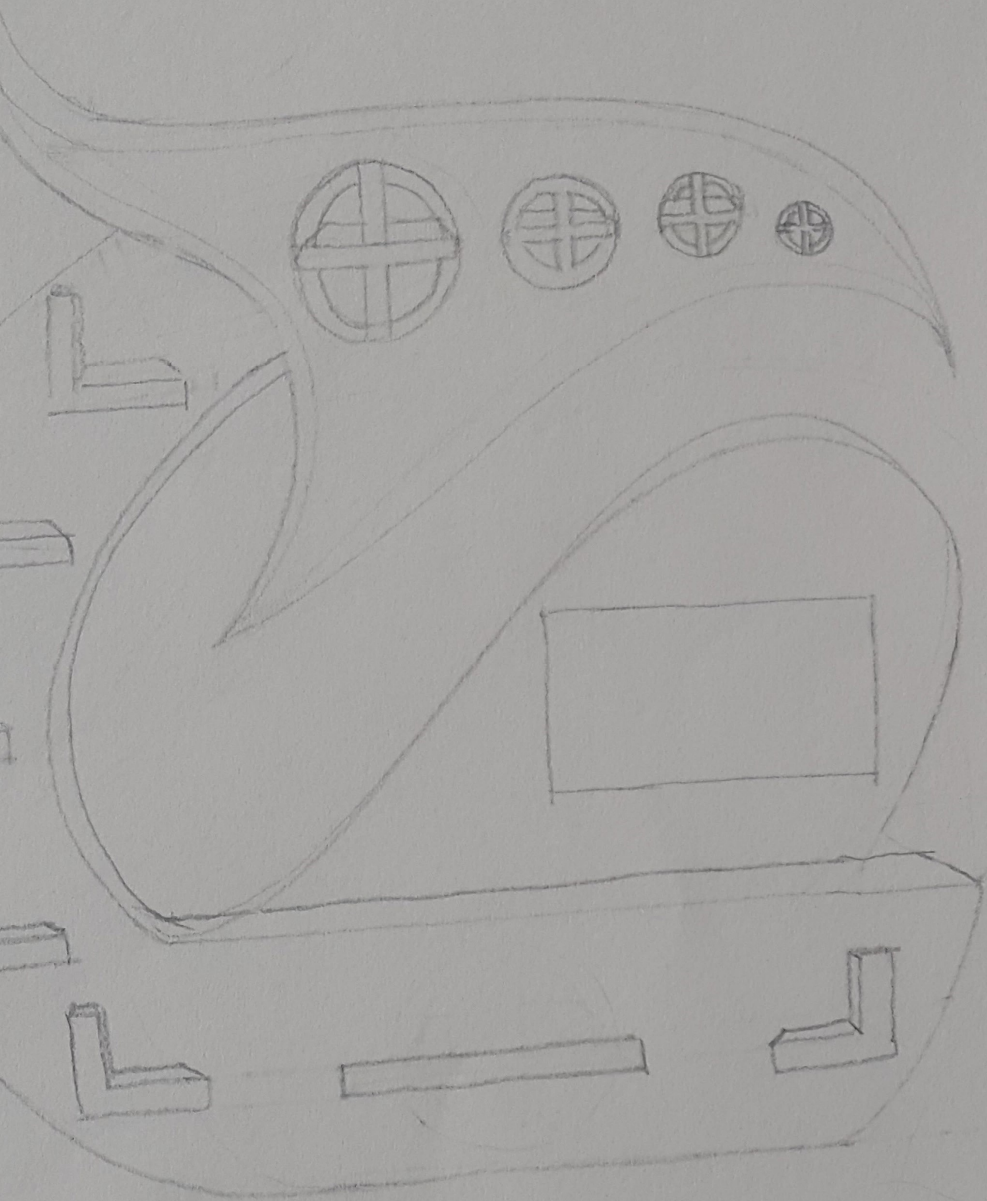

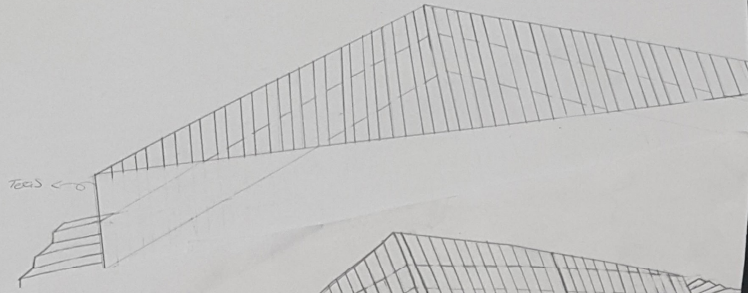

Teras ←

Teras demirlikleri

Yan duvar

Cam

Yeni hava koruyucusu

Kapı

Yükseklik 200

Binemin etrafını saran merdiven

Yaz sönent için teras katının olması sonucu dışarıda oturmak amaçlı masa ve sandal gelir.

GÜZEL SAĞLIKTA FAKÜLTESİ'nde
Engin Akpınar

19.12

Bazak Bazak
18930026

Bazak
26

Bazak Bazak
18930026



Bazak Bazak
18930026

ayıcı Estiz:

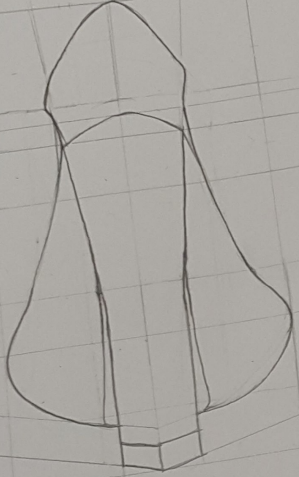

Arka Cf

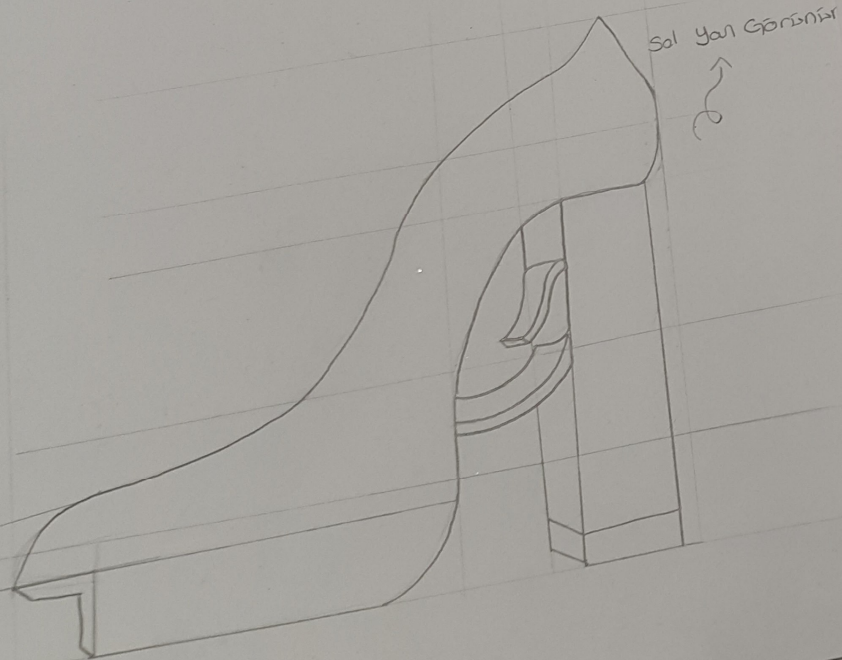

Sol Yan Görünüş

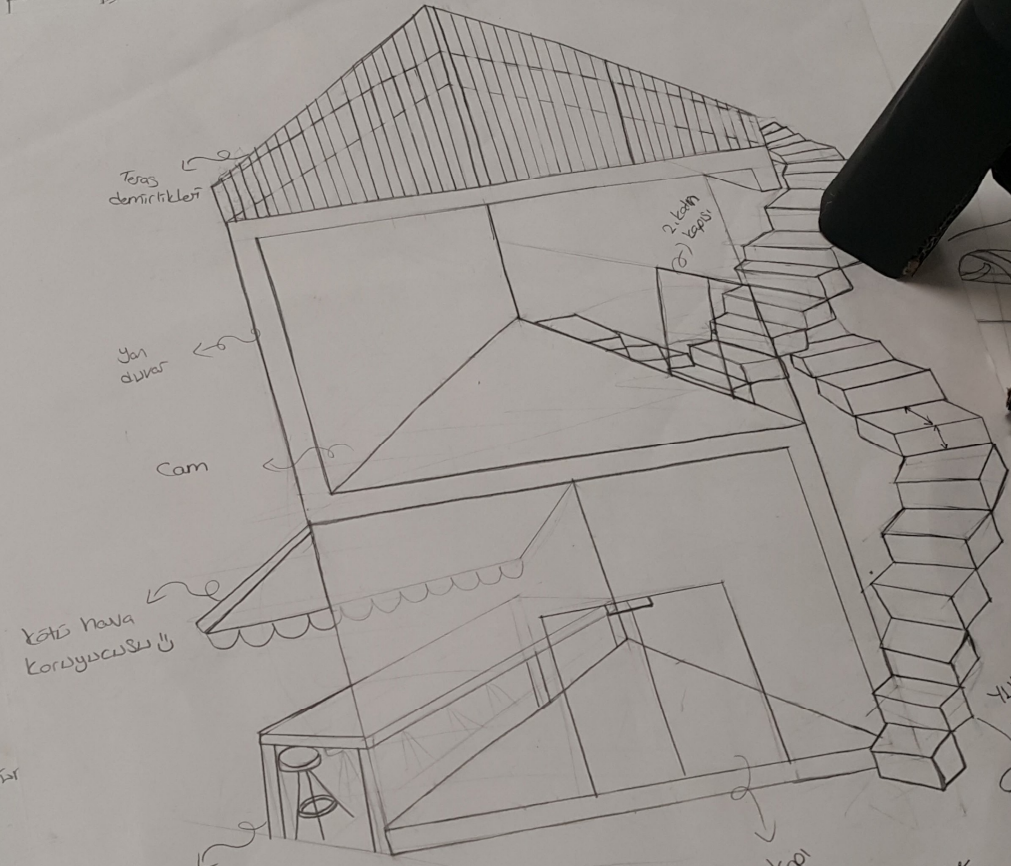

Yaz görleri
Tçin teras katının
olması sonucu dışarı-
da oturmak amaçlı
masa ve sandal gelir.

Yükü
Binemin
etrafını
Sasan masdiren

GÜZEL
SANKI
Fakültesi'nde
Alınan

19.12

Bazık Bazık
18950036

Basık
36

Basık
18950036



19-12

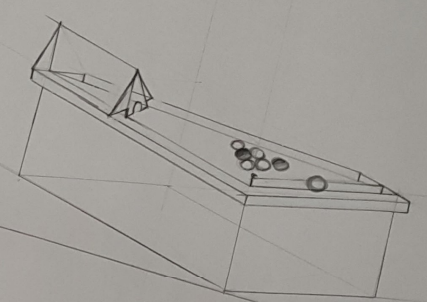

OK
12.12.2019

MARALAR VE OTAN KU
* Oyuna tak kilitler
* Oyuna amaci kirmis
* Top delikler kesi giridiken sonra all taraydan sonra

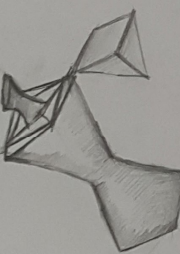
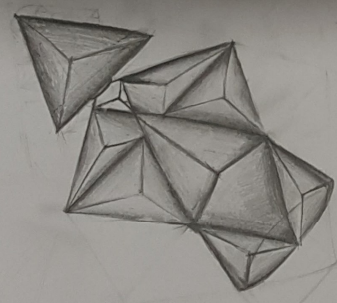

11.11.2019

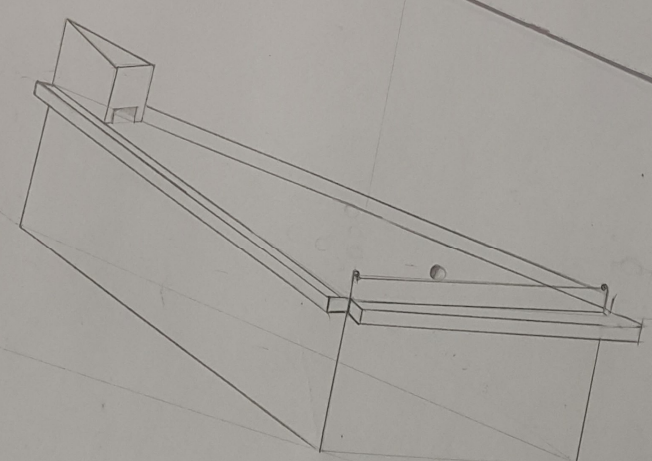

19-12



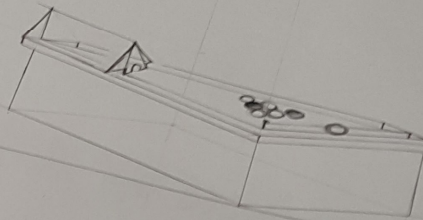
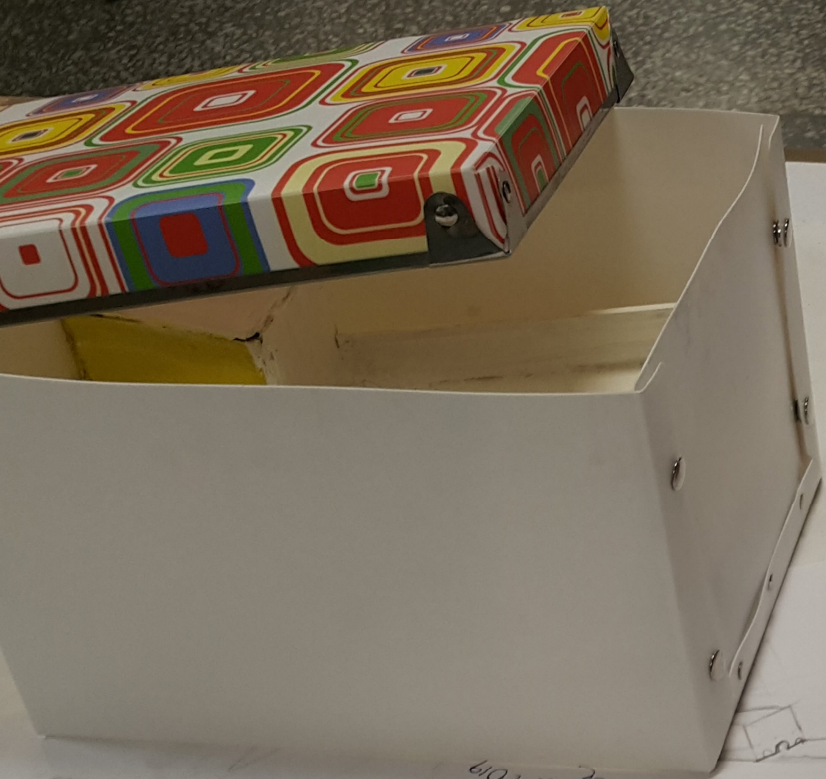

1A
19-12

Phenol
* Ogan let khalak
* Ogan amek kump
* Top dellen saat giridha senca
all kraspan adnial dan

OK
12.12.2019
1A

1A
12

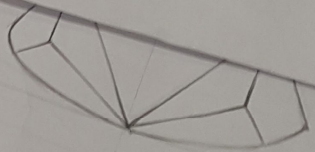
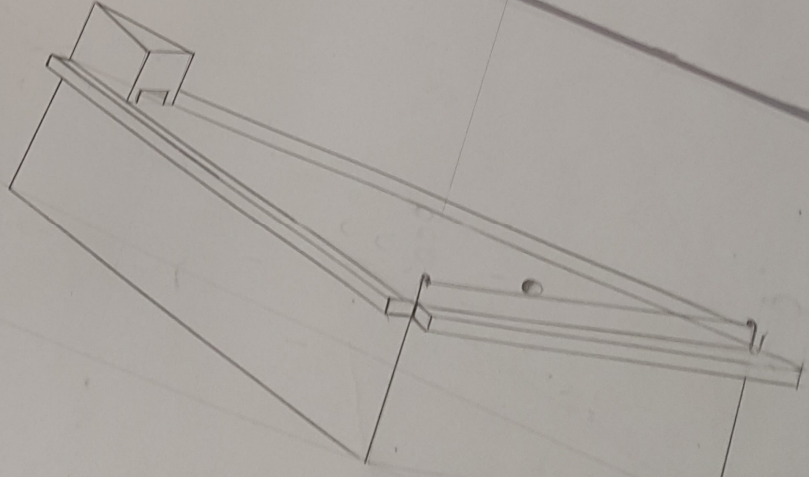
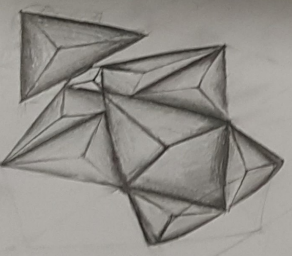

1A
19

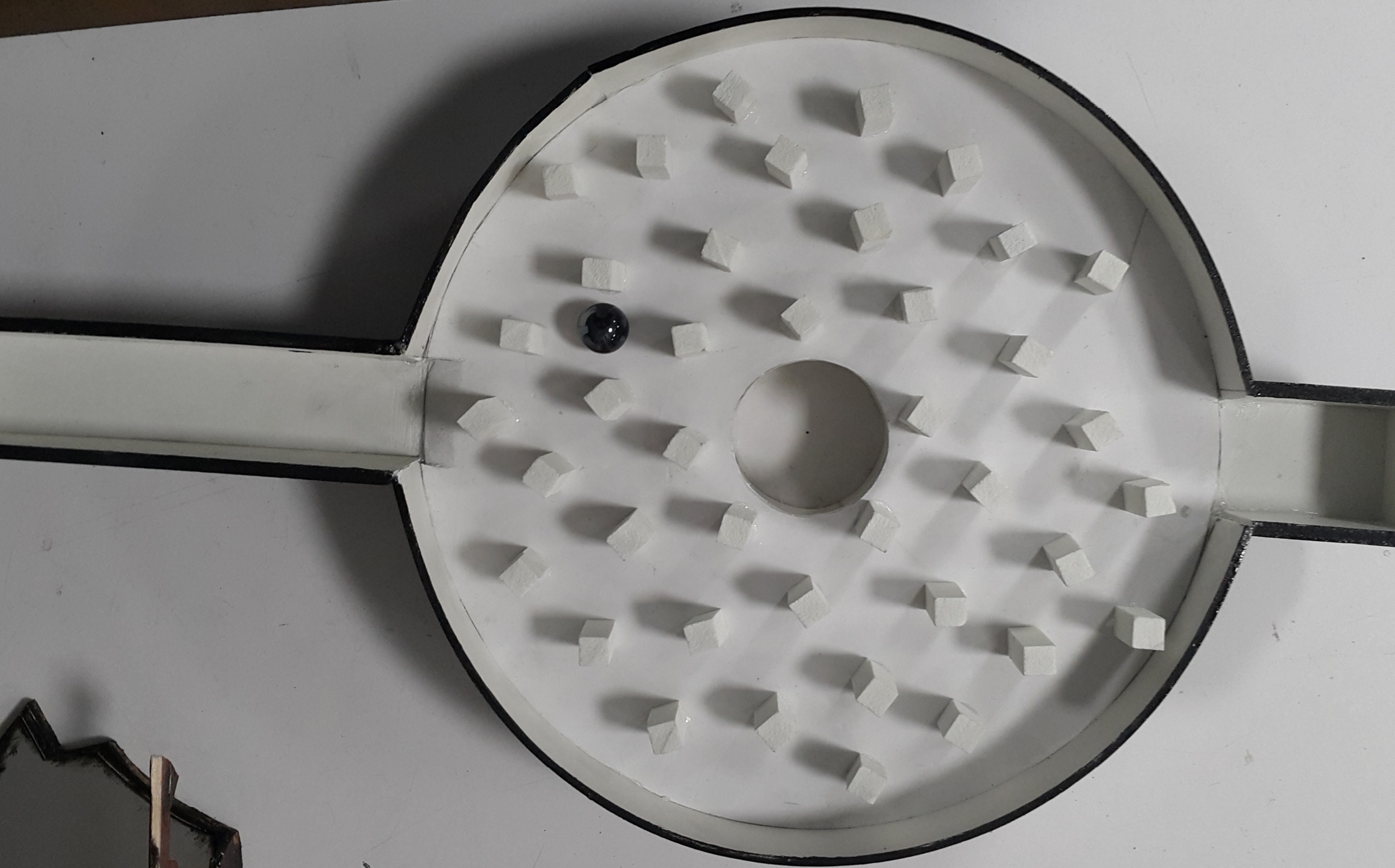

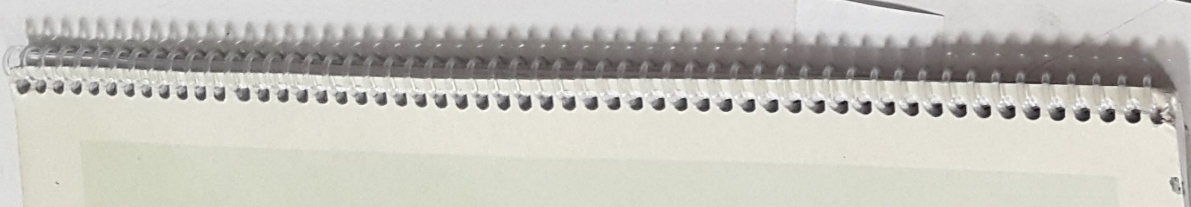

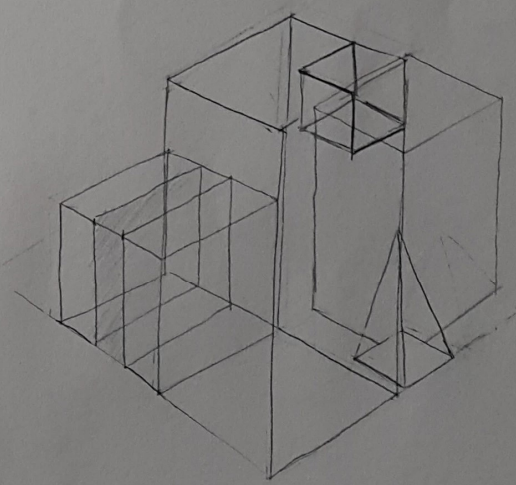
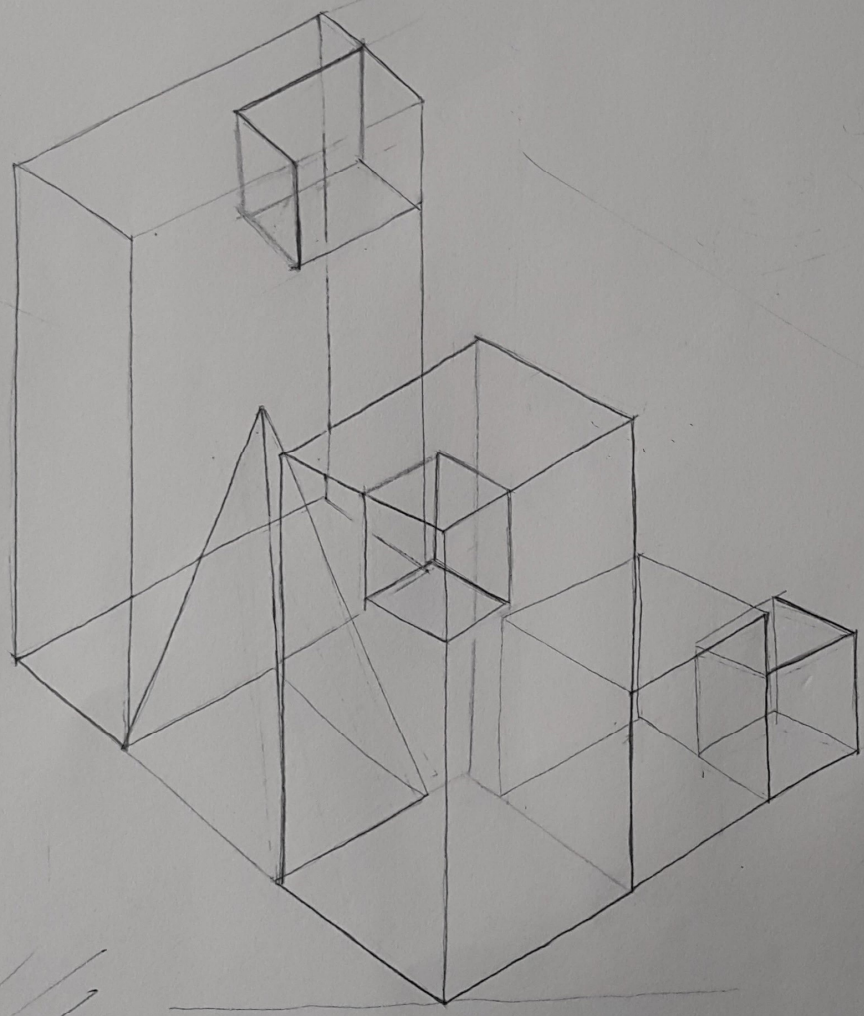
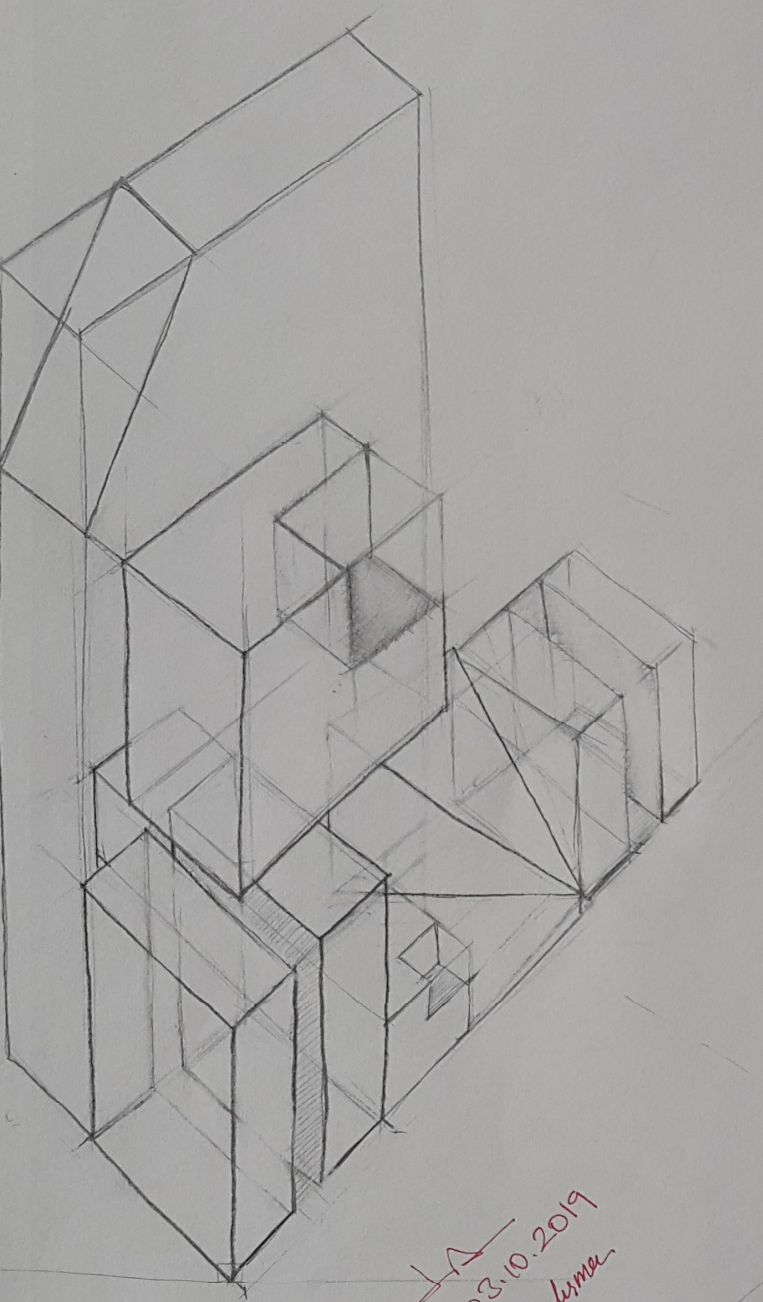

03.10.2019
4 galina

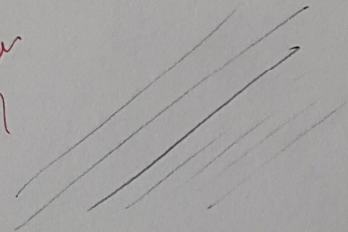

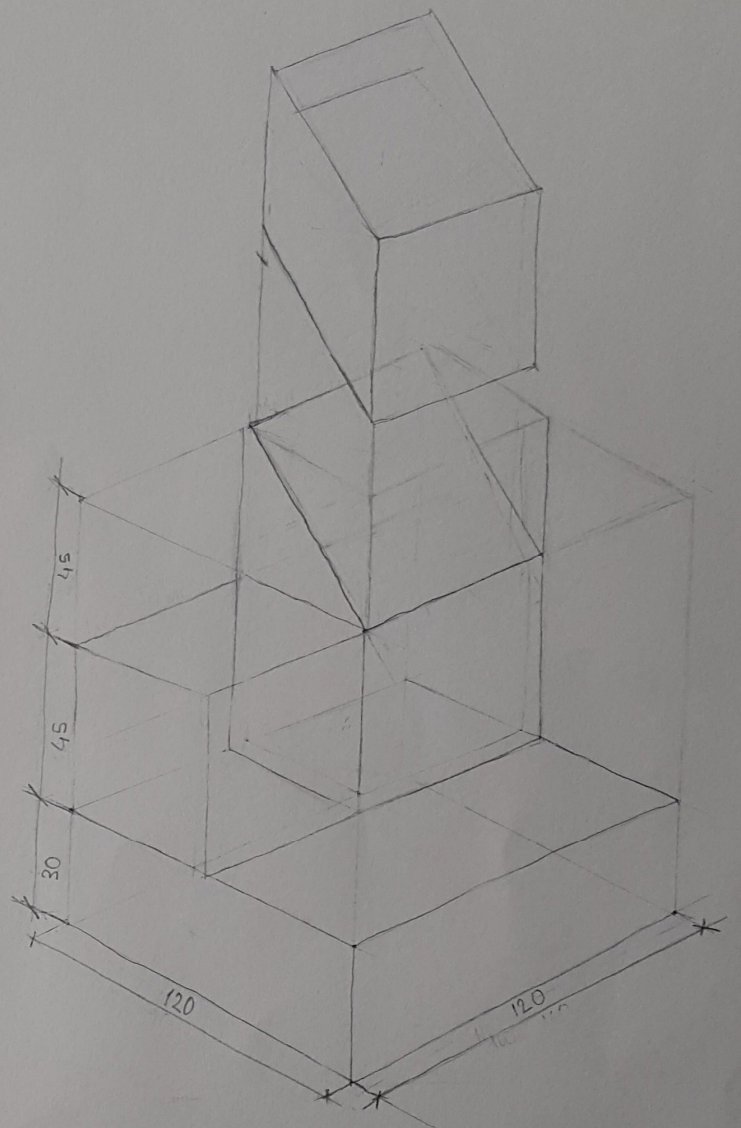
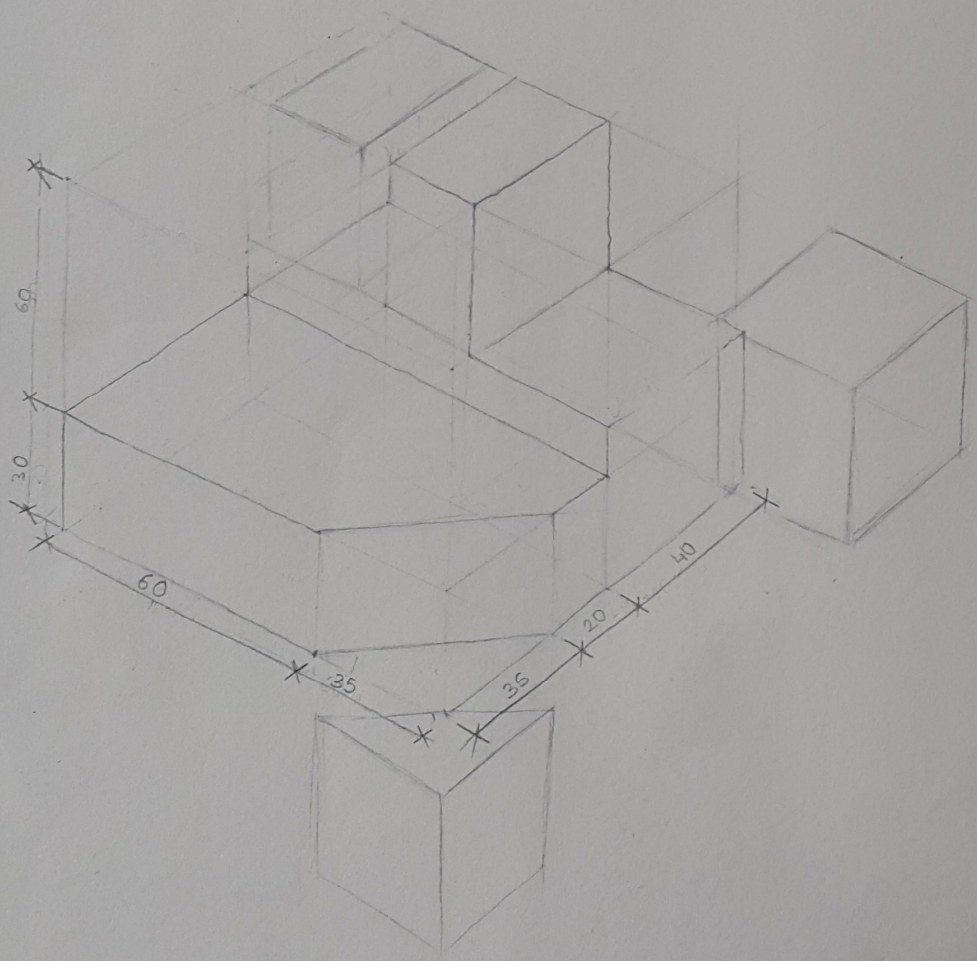

işlem arızası.
 ana şerh girilmesi.

31.10.

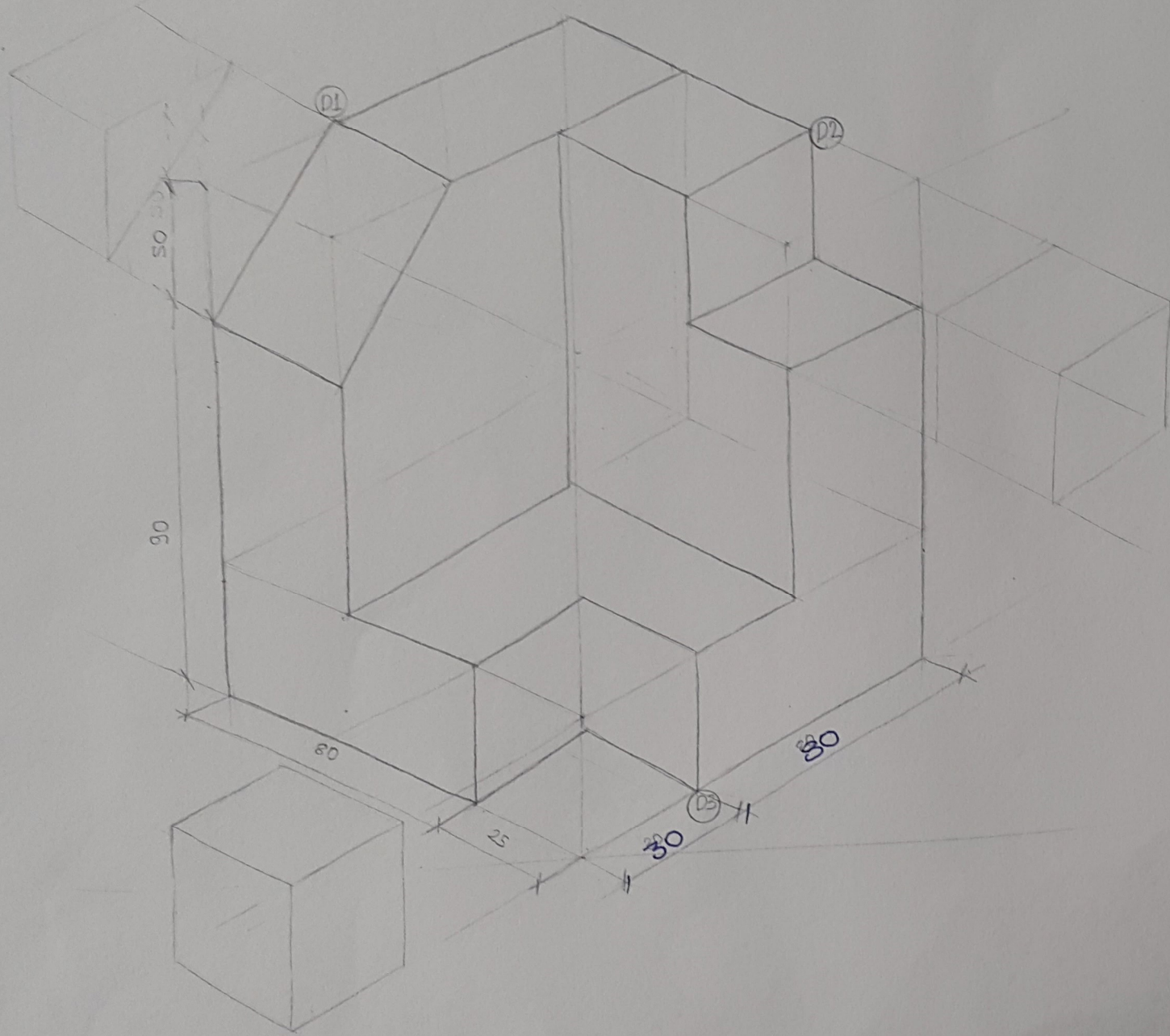

D1 Kesit çıkarma
D2 Kesit çıkarma
D3 Kesit çıkarma

Handwritten signature or initials.

